

Infra-Structure: Rigorous compositions of light and lines, for a unique mark in the architecture.

The Running Magnet 2.0: Solutions for universal installation, dimmable system and upgraded electronics.

The Tracking Magnet: Flos exclusive track system: refined and beautifully miniaturized.

The Tracking Power: Flos solution for the universal three phase use: power, flexibility and integration in large space.

ARCHITECTURAL LIGHTING

The Black Line: Totally glare-free lighting in extremely compact dimensions, now also for continuous lines.

Bon Jour: Timeless beauty joins elegant technology.

Kap: Extended and comfortably refined downlight collection. Johnny: Total versatility with orientation, multiple installation and a wide range of possibilities.

Light Supply: Recessed LED downlight where power is needed. UT Spot: Powerful flexibility, now also available for ceiling installation.

ESPAÑOL / ENGLISH

FLOS
ARCHITECTURAL

Llevamos casi dos décadas suministrando sistemas de iluminación excepcionalmente diseñados y tecnológicamente avanzados para usos muy específicos. Con el firme convencimiento de que la calidad de la luz en sí misma determina la percepción humana, utilizamos el diseño y la tecnología para mejorar espacios y complementar productos. Nuestra propensión hacia la innovación nos hace explorar nuevos caminos, lo que da como resultado una completa gama apta para todo tipo de aplicaciones. Nuestras nuevas colecciones van un paso más allá en esta dirección.

For almost two decades we have been delivering exceptionally designed and technologically advanced lighting systems for very specific uses. In the firm belief that the quality of light itself determines human perception, we use design and technology to enhance spaces and complement products. Our propensity to innovate drives us to explore new paths, resulting in a comprehensive range suitable for all kind of applications. Our new collections mark a further step in this direction.

INFRA-STRUCTURE



p.4

THE RUNNING MAGNET 2.0

Recessed



Surface



Suspension Up&Down / Down



p.24

THE TRACKING MAGNET

Recessed



Surface



Suspension Up&Down / Down



p.52

THE TRACKING POWER

Recessed



p.74

THE BLACK LINE

No Trim



Trim



p.88

BON JOUR



p.104

KAP



p.120

JOHNNY



p.176

LIGHT SUPPLY



p.190

UT SPOT

Track



Ceiling



Downlight



p.210

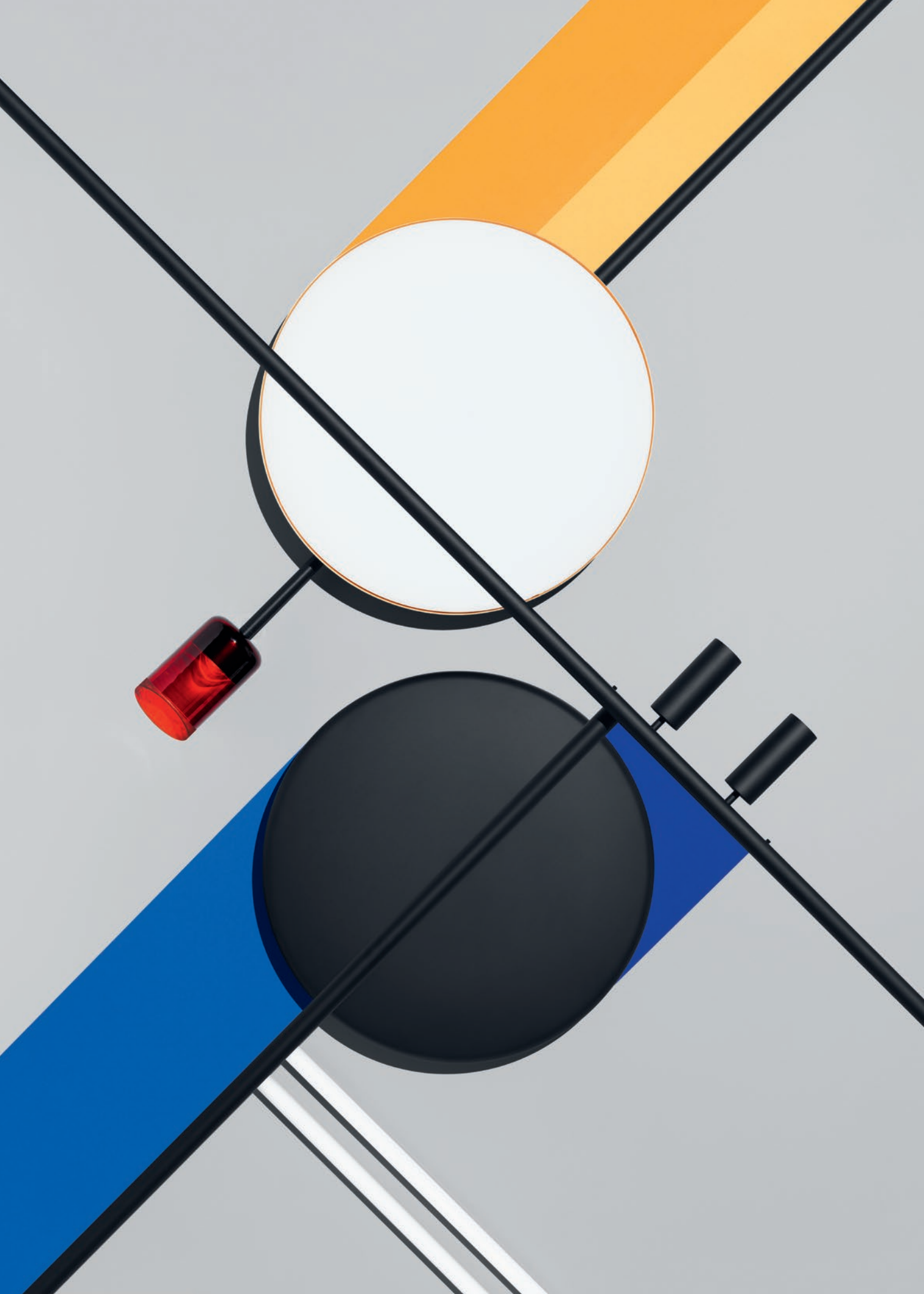

INFRA-STRUCTURE

Interpretación moderna del estilo Bauhaus, con un perfil tubular en aluminio que integra un carril magnético en grafito, para la instalación en superficie de una o más líneas paralelas. Amplia gama de luminarias LED, que proporcionan luz general directa e indirecta, con proyectores direccionables y colgantes. Instalación rápida de las luminarias gracias al exclusivo sistema de conexión magnético y bloqueo mecánico de seguridad.

INFRA- STRUCTURE

A modern interpretation of the Bauhaus style with a tubular steel profile integrating a magnetic graphite rail to be used for surface installations of one or more parallel lines. A full range of LED luminaires that offer general direct and indirect light, with adjustable and hanging projectors. Swift installation of the luminaires thanks to the exclusive magnetic connection system and the mechanic safety block.

DESIGNED BY VINCENT VAN DUYSSEN







Descripción

Innovador sistema de iluminación diseñado por Vincent Van Duysen para instalación en interiores en versión de superficie fijado a techo con sistema de varillas rígidas. Perfiles estructurales y varillas de fijación a techo fabricados con perfiles de aluminio extruido (Al 6063T5) en color negro, provistos de pistas eléctricas de grafito alimentadas a 48V, sobre las cuales se instalan, mediante sistema de fijación magnética con sujeción de seguridad mecánica, las luminarias LED. La familia de luminarias está compuesta por módulos de iluminación de acento con distintas ópticas, sistemas de iluminación ambiental de luz directa e indirecta y luminarias decorativas con el diseño distintivo de Flos.

Sistema Óptico

- Spot Structure 90 - Spot.
- Spot Structure 120 - Spot y Medium.

Unidades de Alimentación

Fuente de alimentación remota de 48V no incluida. Opción de fuente de alimentación de 48V (max 6,7A) integrada en varilla de suspensión.

Accesorios

Para los módulos de iluminación Spot Structure los accesorios de apantallamiento (honeycomb and cruceta) van incorporados en el producto.

Información Adicional

Sistema eléctrico alimentado a 48V. Max 8A y 320W. Cada vez que se completan los 320W, realizar nuevamente conexión de fuente de alimentación. Índice de protección IP20. Instalable en superficies normalmente inflamables.

Cumplimiento de Normativa y Marcas de Calidad

Luminaria conforme con la Normativa Técnica Europea EN60598-1 y partes segundas.

Description

An innovative illumination system designed by Vincent Van Duysen to be installed inside in their surface-mounted version fastened to the ceiling with a rigid rod system. Structural profiles and ceiling fastening rods manufactured with black extruded aluminium tubular sections (Al 6063T5), fitted with an electric graphite feed track with a 48v supply, on which the LED luminaires are installed by a magnetic fastening system and a security mechanical fastening element. The range of luminaires is composed of accent illumination modules with different optics, ambient lighting system with direct and indirect lights and decorative luminaires with the Flos signature design.

Optic system

- Spot Structure 90 - Spot.
- Spot Structure 120 - Spot and Medium.

Power Supply

Remote 48V power supply not included. There is a 48V power supply (max 6,7A) integrated into the suspension rod.

Accessories

For the Spot Structure illumination modules, the cross-screening accessories (honeycomb and crosspieces) are incorporated into the product.

Additional Information

A 48V electric system. Max 8A and 320W. With each 320W make a new connection to a power supply. IP20 protection grade. Suitable for installation on normally inflammable surfaces.

Compliance of Standards and Quality Marks

EN60598-1 European Technical Standards and any subsequent additions.

Colores
Colours



■ 14 Negro
■ 14 Black

LIGHT MODULES

LIGHT TUBE



TOP LED
22W/m
2500 lm/m
2700K/CRI 90
3000K/CRI 90

SPOT
STRUCTURE 90



POWER LED
9,6W
850 lm
2700K/CRI 90
9,6W
900 lm
3000K/CRI 90

SPOT
STRUCTURE 120

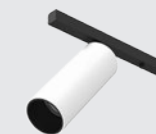

POWER LED
12,5W
985 lm
2700K/CRI 90
12,5W
1060 lm
3000K/CRI 90

DOWNLIGHT
STRUCTURE



LED ARRAY
21,5W
1900 lm
3000K/CRI 90
2700K/CRI 90

SUSPENSION
STRUCTURE



TOP LED
3000K/CRI 80
2700K/CRI 80

INFRA-STRUCTURE — PROFILES

Perfiles / Profiles

Carril electro-magnético tubular para instalación de superficie en techo con fijación mediante varillas rígidas. Perfiles tubulares disponibles en dos longitudes: 1055mm (separación entre varillas 1100mm) y 1555mm (separación entre varillas 1600mm). Los terminales de cierre están también electrificados y han de pedirse por separado. Distintas versiones de varilla de sujeción:

- Varilla mecánica con rosetón de Ø50: para fijación de perfiles.
- Varilla con rosetón de Ø50: varilla de alimentación para instalación remota de la fuente de alimentación en lugar accesible.
- Varilla con rosetón de Ø140: varilla de alimentación para instalación remota de la fuente de alimentación a través del rosetón.
- Varilla de suspensión con equipo integrado: varilla de alimentación que alberga la fuente de alimentación.
- Plantilla de aluminio, para marcar los puntos de fijación para la instalación de las varillas, disponible como producto separado.

An electromagnetic tubular track for surface installation on the ceiling fastened with rigid rods. Tubular profiles available in two lengths: 1055 mm (1100 mm separation between rods) and 1555 mm (1600 mm separation between rods). The closure terminals will also be electrified and must be ordered separately. Different versions of fastening rods:

- Mechanic rod with a Ø50 connection rose: to fasten profiles.
- Rod with a Ø50 connection rose: a supply rod for remote installation of the power supply in an accessible place.
- Rod with a Ø140 connection rose: a supply rod for remote installation of the power supply through the connection rose.
- Suspension rod with an integrated equipment: supply rod housing the power supply.
- Aluminium stencil to mark the points for installing the rods available as separate item.

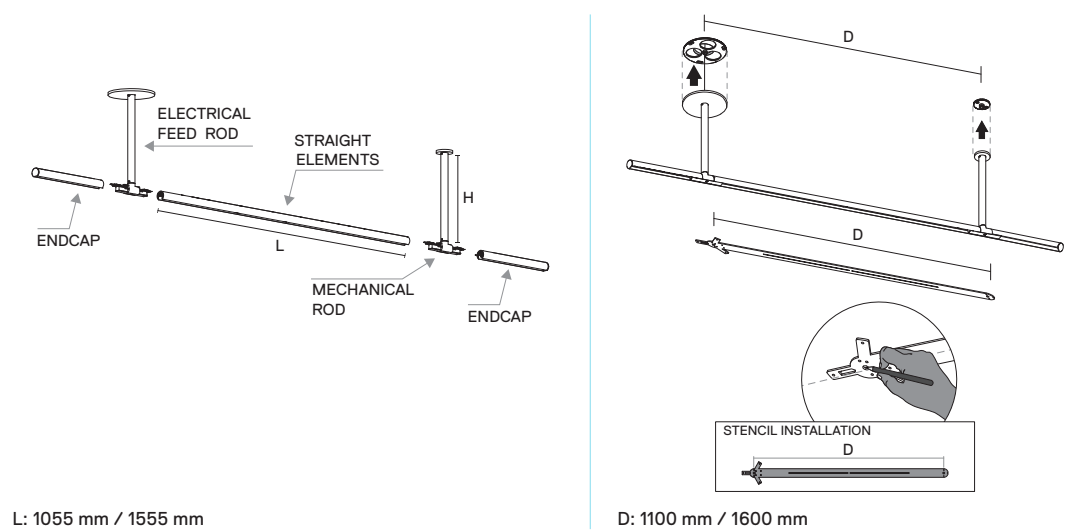

Elementos Lineales / Straight Elements

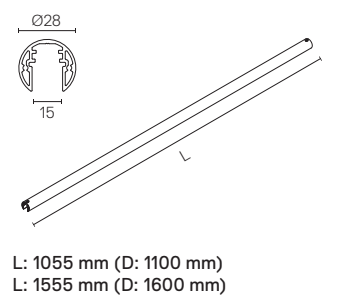

Varilla Mecánica Rosetón ø50 mm / Mechanical Rod ø50 mm Rose

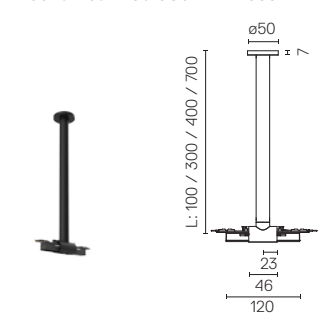

Varilla Eléctrica de Alimentación Rosetón ø50 mm / Electrical Feed Rod ø50 mm Rose

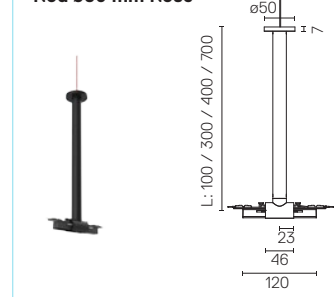

Varilla Eléctrica de Alimentación Rosetón ø140 mm / Electrical Feed Rod ø140 mm Rose

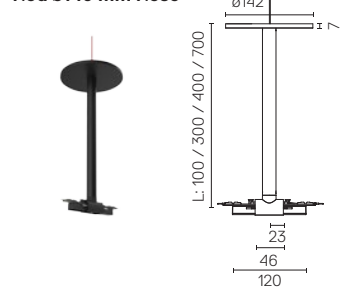

Varilla de Suspensión con Caja de Alimentación / Box Power Supply Suspension Rod

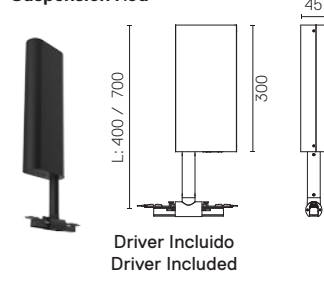

Terminal / Endcap



INFRA-STRUCTURE — LIGHT MODULES

LIGHT TUBE DIRECT

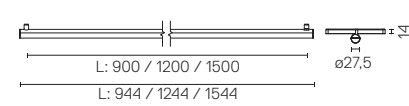
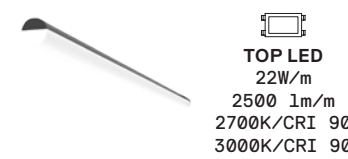

900 mm - 2700K
Direct
■ 03.6391.14
Indirect
■ 03.6394.14

LIGHT TUBE INDIRECT

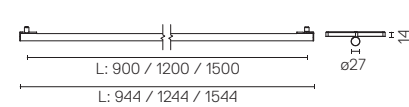

900 mm - 3000K
Direct
■ 03.6385.14
Indirect
■ 03.6388.14

Módulo de iluminación LED de luz difusa para ser instalado en el sistema Infra-Structure. Elementos de fijación giratorios 0°-90°, con conexión magnética y bloque de seguridad mecánico, para instalación paralela en un único perfil de la estructura o transversal entre dos líneas de perfil. Los Light Tubes solo se alimentan por uno de los extremos y no comunican corriente a través del otro extremo.

Diffused LED light module to be installed in The Infra-Structure System. Turning fastening elements 0°-90° with a magnetic connection and mechanic security block for a parallel installation one one single profile of the structure or transversally between to lines of the profile. The Light Tube are only fed by one of the ends and do not communicate current through the other end.

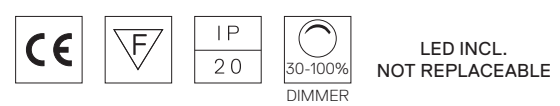

1200 mm - 2700K
Direct
■ 03.6392.14
Indirect
■ 03.6395.14

1200 mm - 3000K
Direct
■ 03.6386.14
Indirect
■ 03.6389.14

1500 mm - 2700K
Direct
■ 03.6393.14
Indirect
■ 03.6396.14

1500 mm - 3000K
Direct
■ 03.6387.14
Indirect
■ 03.6390.14

SPOT STRUCTURE 90



POWER LED
9,6W
850 lm
2700K/CRI 90
9,6W
900 lm
3000K/CRI 90

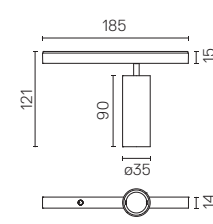

Módulo de iluminación LED de acento para ser instalado en el sistema Infra-Structure. Convertidor electrónico de corriente DC/DC incorporado. Accent lighting LED module to be installed in The Infra-Structure System. Built-in DC/DC electronic voltage converter.

2700K
■ 03.6470.40
■ 03.6470.05
■ 03.6470.14
3000K
■ 03.6471.40
■ 03.6471.05
■ 03.6471.14

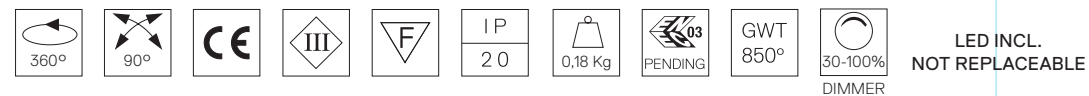

Straight Elements

1055 mm
■ 06.1900.14
1555 mm
■ 06.1901.14

Mechanical Rod

ø50 mm Rose
100 mm
■ 06.1906.14
300 mm
■ 06.1907.14
400 mm
■ 06.1908.14
700 mm
■ 06.1909.14

Electrical Feed Rod

ø50 mm Rose
100 mm
■ 06.1913.14
300 mm
■ 06.1914.14
400 mm
■ 06.1915.14
700 mm
■ 06.1916.14
ø140 mm Rose
100 mm
■ 06.1902.14
300 mm
■ 06.1903.14
400 mm
■ 06.1904.14
700 mm
■ 06.1905.14

Box Power Supply

Suspension Rod
400 mm
■ 06.1912.14
700 mm
■ 06.1910.14

Endcap

■ 06.1911.14

Aluminium Stencil

Installation
1100 mm
08.0032.00
1600 mm
08.0033.00

INFRA-STRUCTURE — LIGHT MODULES

SPOT STRUCTURE 120



POWER LED
12,5W
985 lm
2700K/CRI 90

12,5W
1060 lm
3000K/CRI 90

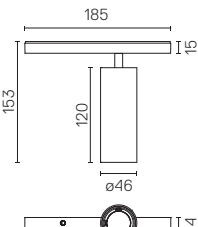

Módulo de iluminación LED de acento para ser instalado en el sistema Infra-Structure. Convertidor electrónico de corriente DC/DC incorporado.

2700K
03.6475.40
03.6475.14
3000K
03.6476.40
03.6476.14



Accent lighting LED module to be installed in The Infra-Structure System. Built-in DC/DC electronic voltage converter.

2700K
03.6477.40
03.6477.14
3000K
03.6478.40
03.6478.14

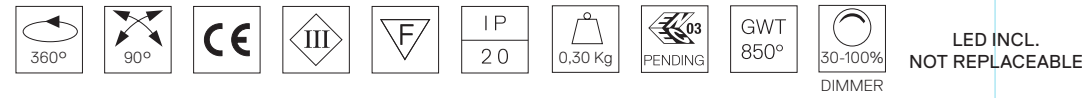
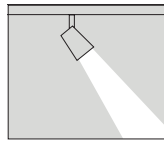

DOWNLIGHT STRUCTURE



LED ARRAY
21,5W
1900 lm
3000K/CRI 90
2700K/CRI 90

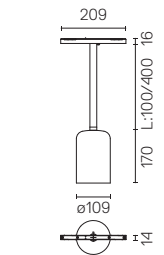

Luminaria suspendida para ser instalada en el sistema Infra-Structure. Convertidor electrónico de corriente DC/DC incorporado.

L: 100 mm
2700K
03.6480.00
03.6480.FU
03.6480.RC
3000K

Suspension luminaire to be installed in The Infra-Structure System. Built-in DC/DC electronic voltage converter.

03.6481.00
03.6481.FU
03.6481.RC

L: 400 mm
2700K
03.6482.00
03.6482.FU
03.6482.RC
3000K
03.6483.00
03.6483.FU
03.6483.RC

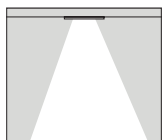

00 Cristal Transparente / 00 Transparent Glass
FU Cristal Fumé / FU Smoked Glass
RC Cristal Rojo / RC Red Glass

INFRA-STRUCTURE — LIGHT MODULES

SUSPENSION STRUCTURE



TOP LED
3000K/CRI 80
2700K/CRI 80

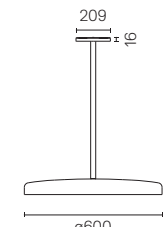

Luminaria suspendida para ser instalada en el sistema Infra-Structure. Convertidor electrónico de corriente DC/DC incorporado.

L: 100 mm
2700K
E I
03.6485.14
3000K
03.6486.14

Suspension luminaire to be installed in The Infra-Structure System. Built-in DC/DC electronic voltage converter.

L: 400 mm
2700K
03.6487.14
3000K
03.6488.14

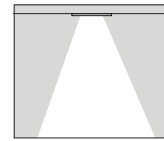
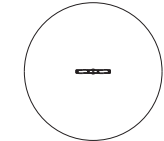

Equipos Drivers

Fuente de alimentación LED para instalación remota en cuadro eléctrico 48V/320W. Para evitar problemas de sobrecarga se recomienda instalar una fuente de alimentación cada 320W.



60.8919

LED power supply source for remote installation in 48V/320W electric control panel. To avoid problems of overload it is recommended to install a power source every 320W.

E= Acabado Externo / I= Acabado Interno.
E= External Finish / I= Internal Finish.



Sistema de fijación magnética con sistema de seguridad mecánico que permite la instalación de los módulos de luz sin cables.

A magnetic fastening system with a mechanic safety system that permits installation of light modules with no cables.



Sistema de regulación lumínico integrado en el cuerpo de la luminara.

Regulation system for light dim integrated into the body of the luminaire.



**TRES PREGUNTAS,
TRES RESPUESTAS,
TRES SISTEMAS.**

**THREE QUESTIONS,
THREE ANSWERS,
THREE SYSTEMS.**

THE RUNNING MAGNET 2.0

Sistema diseñado para una total integración con la arquitectura, ofreciendo una flexibilidad total en sus configuraciones gracias a su exclusivo carril de 24V con instalación magnética de las luminarias. El Running Magnet 2.0 ofrece la posibilidad de control via DALI o con potenciómetro integrado en cada luminaria, complementando la familia con luminarias icónicas de la colección decorativa de Flos, además de las soluciones de proyectores de alta potencia.

System designed for a total integration into the architecture, offering total flexibility of configurations thanks to its exclusive 24V track with magnetic luminaire installation. The Running Magnet 2.0 can be controlled either as system via DALI or with an on-board potentiometer on each luminaire. The technical range is completed by an offer of iconic luminaires from Flos most successful decorative collections as well as by solutions for high power spots.

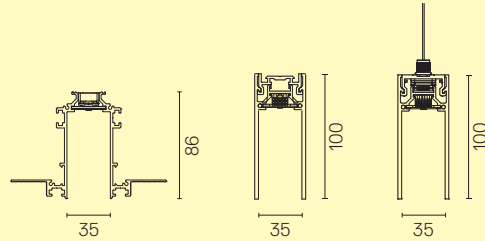

THE TRACKING MAGNET

Sistema diseñado para un máximo nivel de miniaturización y un impacto visual mínimo, ofreciendo soluciones para cualquier necesidad de instalación. La exclusiva instalación magnética de 24V de Flos proporciona flexibilidad de configuración para una amplia gama de proyectores disponibles, todos ellos con electrónica muy compacta, además de completarse con soluciones de alta potencia.

System designed for maximum level of miniaturization and minimum visual impact of track, offering solutions for any installation need. The Flos exclusive 24V magnetic luminaire installation provides flexible configurations for the wide selections of spots available, all featuring super compact electronic, is also completed with high power solutions.

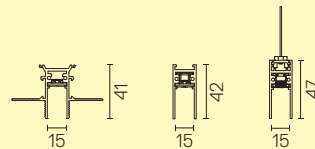

THE TRACKING POWER

Sistema trifásico único para instalaciones empotradas con un diseño minimalista y refinado. Con solo 15mm de ancho una vez instalado, ofrece una total integración en la arquitectura. El sistema lo completa una amplia gama de luminarias profesionales: potentes proyectores, bañadores de pared y módulos de iluminación general, combinados con la electrónica exclusiva de Flos para una integración visual total. Disponibles soluciones de control de carriles trifásicos estándar.

Unique three phase power track system for recessed installation with minimal and refined design, only 15 mm wide once installed, offering total architectural integration. The system is completed by a full range of professional luminaires: powerful spots, wall-washer and general lighting modules, featuring the unique Flos power electronic for total visual integration. Solutions for standard three phase track and for system control are also available.

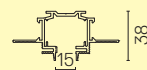

THE RUNNING MAGNET 2.0 - 24V

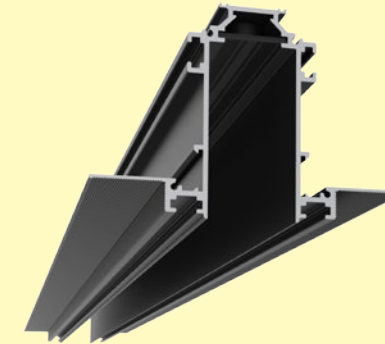

THE TRACKING MAGNET - 24V



THE TRACKING POWER - 110V-240V

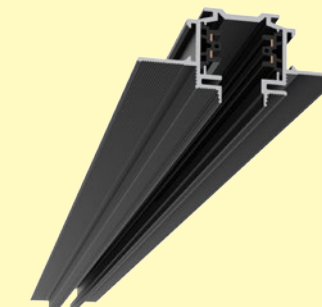

Un signo gráfico en la arquitectura, gracias a la elegante alternancia de luz y oscuridad, con instalación empotrada, de superficie o suspendida. Máxima flexibilidad proporcionada por el sistema exclusivo de fijación magnética de las luminarias. Gran versatilidad de luminarias, también disponibles en versión regulable DALI.

THE RUNNING MAGNET 2.0

A graphic sign in the architecture, thanks to the elegant alternation between light and darkness, with an embedded, surface or suspended installation. Maximum flexibility offered by the exclusive magnetic fastening system. Great versatile luminaires, also available in DALI adjustable versions.







SEB OFFICES - U.K.

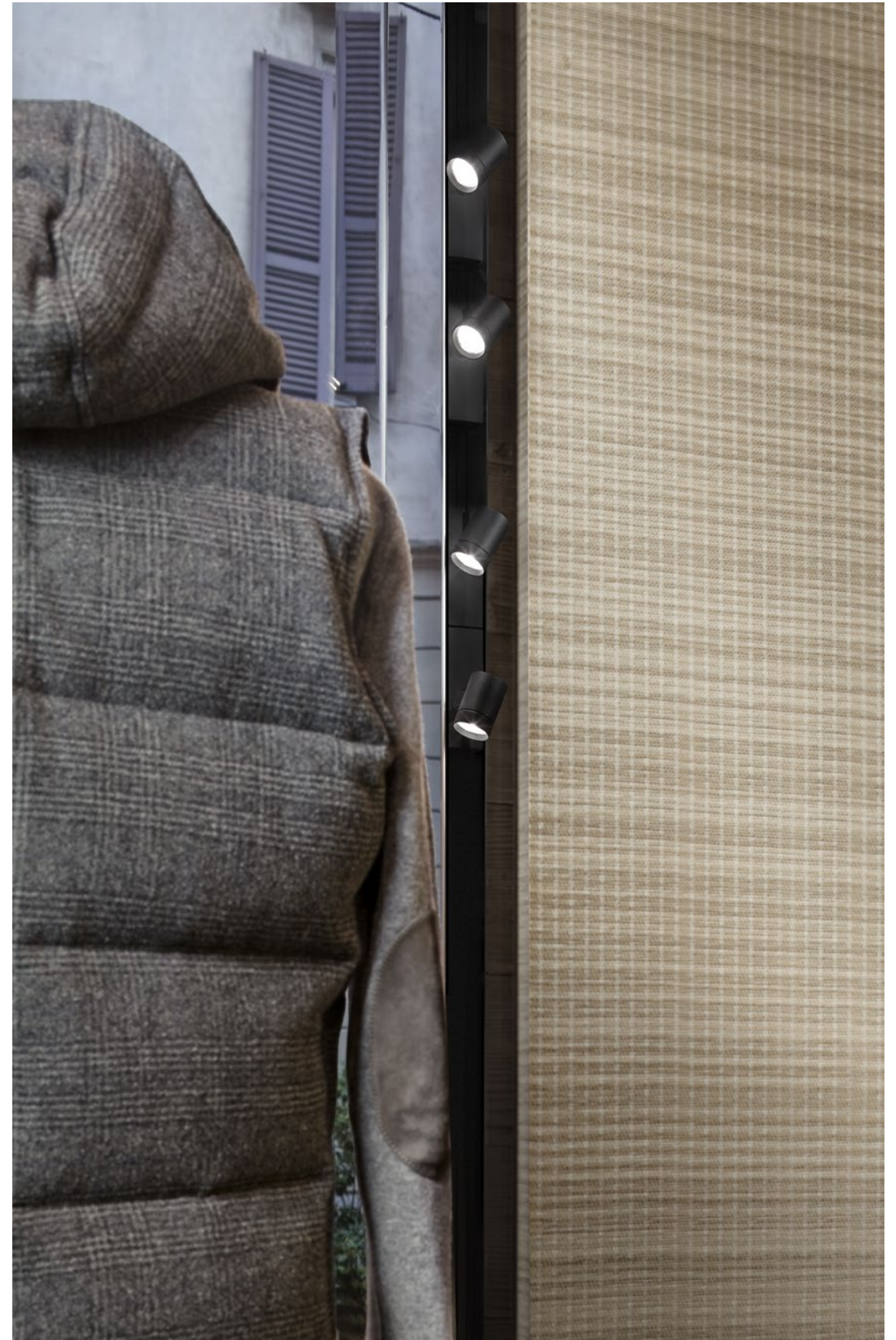

LUCIANO BARBERA - MILANO



Descripción

Innovador sistema de iluminación para interior en versiones superficie, suspendida o empotrada en pared/techo de cartón yeso. Compuesto por perfilera magnética donde se posicionan, mediante sistema de fijación magnética, módulos de iluminación.

Todos los perfiles estructurales del Running Magnet 2.0 han sido fabricados con perfilera de aluminio extruido en blanco y negro, provisto de pistas eléctricas de grafito alimentadas a 24V, sobre las cuales se instalan mediante un sistema de fijación magnética las luminarias LED.

La versión suspendida también está disponible para luz indirecta.

La familia The Running Magnet 2.0 se completa con módulos de iluminación ambiental y de acento, con diferentes ópticas además de luminarias decorativas acorde a la mayoría de las colecciones Flos.

Los módulos de iluminación incorporan un sistema de fijación magnética que permite una completa movilidad y flexibilidad. Todos los módulos de luz disponen de un potenciómetro instalado o regulación DALI según se desee.

Sistema Óptico

El módulo de luz de acento se encuentra disponible con óptica intensiva (spot lens) y con ópticas extensivas (narrow y wide narrow lens).

Unidades de Alimentación

Fuente de alimentación remota de 24V no incluida.

Accesorios

- diferentes lentes para Spot Module y Multi Spot 4.
- aro exterior apantallador para Spot Module.
- lente elíptica y honeycomb para Anthony Spot track.
- honeycomb y cruceta incluidos en Spot 120.

Información Adicional

Únicamente instalable en superficies de cartón yeso de 12,5mm de espesor para la versión Recessed.

The Running Magnet 2.0 es un sistema eléctrico alimentado a 24V y limitado a una corriente máxima de 8A y 185W para evitar sobrecargas.

Cada vez que completemos los 185W deberemos realizar nuevamente la conexión mediante un perfil de alimentación.

En la versión Up&Down la iluminación indirecta y el carril electro-mecánico tienen alimentaciones independientes. Índice de protección IP20.

Instalable sobre superficies normalmente inflamables. Las luminarias del Running Magnet 2.0 no son compatibles con el Running Magnet 1.0.

Cumplimiento de Normativa y Marcas de Calidad

Luminaria conforme con la Normativa Técnica Europea EN60598-1 y partes segundas.

Description

Innovative lighting system for indoor use, for surface, suspended or recessed mounting on plasterboard walls or ceilings, comprising a series of magnetic tracks that house the LED lighting modules.

The profile of all The Running Magnet 2.0 structural tracks is extruded aluminum, painted black or white, housing a graphite electric track fed at 24V, on which all magnetic luminaires are installed simply by insertion.

Suspended track is also available with the option of indirect lighting.

The system also has ambient and accent lighting modules, with different optics, and decorative luminaires like most Flos collections.

The lighting modules incorporate a magnetic mounting system for total mobility and flexibility. All light modules are available with on board potentiometer or in the DALI dimmable option.

Optic system

The accent light module is available with intensive optics (spot lens) and extensive optics (narrow and wide narrow lens).

Power Supply

Remote 24V power supply not included.

Accessories

- different lenses for Spot Module and Multi Spot 4.
- screening external ring for Spot Module.
- elliptical lens and honeycomb for Anthony Spot Track.
- honeycomb and crosspiece included in Spot 120.

Additional Information

The Recessed version can only be installed on 12.5 mm thick plasterboard surfaces.

The Running Magnet 2.0 is a 24V electrical system limited to a maximum power current of 8A and 185W to avoid overloads.

After every 185W make a new connection with a feed unit profile.

In the Up&Down version indirect illumination and the electromechanical track are powered independently. IP20 protection grade.

Suitable for installation on normally inflammable surfaces. Running Magnet 2.0 luminaires are not compatible with Running Magnet 1.0.

Compliance of Standards and Quality Marks

EN60598-1 European Technical Standards and any subsequent additions.

LIGHT MODULES

LIGHT STRIPE

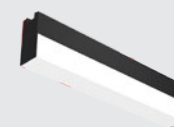

TOP LED
25W/m
2266 1m/m
2700K/CRI 80
2333 1m/m
3000K/CRI 80

SPOT MODULE



POWER LED
8W
560 1m
2700K/CRI 90
8W
600 1m
3000K/CRI 90

SPOT 120



POWER LED
12,5W
985 1m
2700K/CRI 90
12,5W
1060 1m
3000K/CRI 90

MULTI SPOT 4



POWER LED
10W
4x210 1m
2700K/CRI 90
3000K/CRI 90

STRING LIGHT



LED ARRAY
17W
1785 1m
2700K/CRI 90
17W
1870 1m
3000K/CRI 90

MINI GLO-BALL



POWER LED
7W
2700K/CRI 80
3000K/CRI 80



POWER LED
3,5W
2700K/CRI 80
3000K/CRI 80

FIND ME SUSPENSION

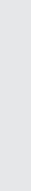

POWER LED
8W
560 1m
2700K/CRI 90
8W
600 1m
3000K/CRI 90

ANTHONY SPOT TRACK



LED ARRAY
17W
1785 1m
2700K/CRI 90
17W
1870 1m
3000K/CRI 90

**Colores
Colours**

RECESSED



■ 14 Negro
■ 14 Black

SURFACE



□ 40 Blanco
□ 40 White

SUSPENSION
UP&DOWN / DOWN



■ 14 Negro
■ 14 Black

THE RUNNING MAGNET 2.0 RECESSED — PROFILES

Perfiles / Profiles

Carril electro-mecánico para instalaciones empotradas en techos/paredes de cartón yeso.

Carriles lineales disponibles en dos versiones: perfiles de alimentación, para conexión a driver, y perfiles intermedios. Ambas versiones con longitudes de 1m a 3m. Tapas incluidas en los perfiles de alimentación.

Disponibles esquinas de 90° en el mismo plano (elemento simétrico para esquina izquierda y derecha), esquinas simétricas de 90° en distinto plano en interior y exterior. Provistos para conexión a driver.

Kits de sujeción, fijo o ajustable, disponibles (opcional). Los Kits de sujeción a techo permiten la instalación sin necesidad de perfiles de aluminio de sujeción. Recomendado para instalaciones en las que se puede instalar el perfil Running Magnet 2.0 antes que el falso techo de cartón yeso.

Electromechanical track for recessed installation in plasterboard ceilings and walls.

Linear tracks available in two versions: power feed profiles for connecting to a driver, and intermediate profiles. Both versions available in lengths from 1m to 3m. Covers included with the power feed profiles.

90° corners available in the same plane (symmetrical element for left and right corners), symmetrical 90° inner and outer corners in different planes. For connection to the driver.

Permanent or adjustable fastening kits available (optional). The fastening kits for the roof permit installing without using aluminum fastening profiles. Recommended for installations where the Running Magnet 2.0 cannot be installed before the suspended plasterboard ceiling.

Elementos Lineales / Straight Elements

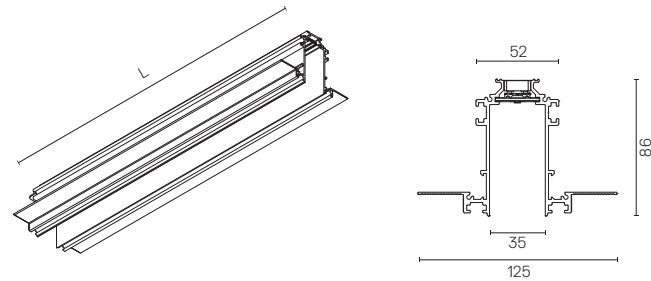

L: 1 m / 1,5 m / 2 m / 2,5 m / 3 m

Esquina 90° / 90° Corner

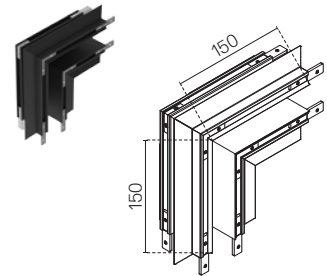

Esquina Interior / Inner Corner

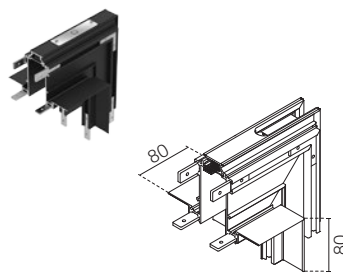

Esquina Exterior / Outer Corner

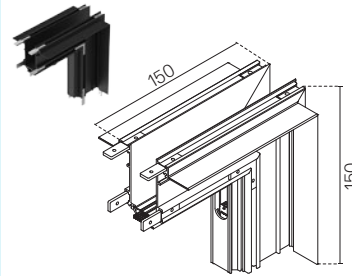

Kit de Sujeción a Techo Fijo / Fixed Ceiling Kit (optional)

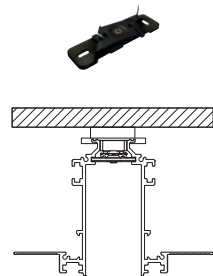

Kit de 2 Unidades
2 Unit Kit

Kit de Sujeción a Techo Ajustable / Adjustable Ceiling Kit (optional)

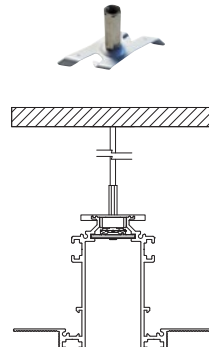

Kit de 2 Unidades
2 Unit Kit

Profile (mm)	Quantities Ceiling Kit (units)
1000/1500	2
2000/2500	3
3000	4

Accesorios Accessories

Las tapas van incluidas con todos los perfiles de alimentación. Se deben pedir por separado, solo si la instalación está compuesta por perfiles intermedios y alimentada en las esquinas esquinas, exclusivamente.

Endcaps come complete with all the feed unit profiles. These should only be ordered separately if the installation is exclusively composed of intermediate profiles and fed by corners.



THE RUNNING MAGNET 2.0 SURFACE — PROFILES

Perfiles / Profiles

Carril electro-mecánico para instalaciones en superficie.

Carriles lineales disponibles en dos versiones: perfil de alimentación, para conexión a driver, y perfiles intermedios. Ambas versiones con longitudes de 1m a 3m.

Tapas incluidas en los perfiles de alimentación. Accesorios de fijación incluidos en todos los productos.

Disponibles esquinas de 90° en el mismo plano (elemento simétrico para esquina izquierda y derecha) y esquinas simétricas de 90° en distinto plano en interior, comunes en versiones Surface y Down. Provistos para conexión a driver.

Electromechanical track for surface-mounting.

Linear tracks available in two versions: power feed profiles for connecting to a driver, and intermediate profiles. Both versions available in lengths from 1m to 3m.

Covers included with the power feed profiles. Attachment accessories included with all products.

90° corners available in the same plane (symmetrical element for left and right corner) and 90° symmetrical internal corners in a different plane, for the Surface and Down versions. For connection to the driver.

Elementos Lineales / Straight Elements

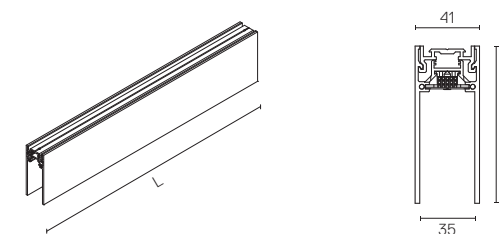

L: 1 m / 1,5 m / 2 m / 2,5 m / 3 m

Esquina 90° / 90° Corner

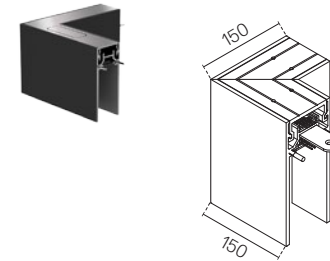

Esquina Interior / Inner Corner

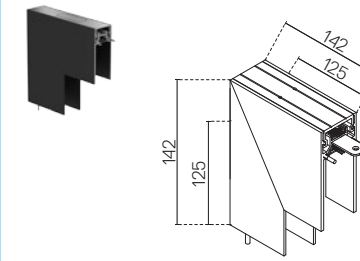

Accesorios Accessories

Las tapas van incluidas con todos los perfiles de alimentación. Se deben pedir por separado, solo si la instalación está compuesta por perfiles intermedios y alimentada en las esquinas esquinas, exclusivamente.

Endcaps come complete with all the feed unit profiles. These should only be ordered separately if the installation is exclusively composed of intermediate profiles and fed by corners.



Perfiles de Alimentación Feed Unit Profiles

1000 mm
06.1600.40
06.1600.14

1500 mm
06.1601.40
06.1601.14

2000 mm
06.1602.40
06.1602.14

2500 mm
06.1603.40
06.1603.14

3000 mm
06.1604.40
06.1604.14

90° Corner
06.1610.40
06.1610.14

Inner Corner
06.1612.40
06.1612.14

Perfiles Intermedios
Intermediate Profiles
1000 mm
06.1605.40
06.1605.14

1500 mm
06.1606.40
06.1606.14

2000 mm
06.1607.40
06.1607.14

2500 mm
06.1608.40
06.1608.14

3000 mm
06.1609.40
06.1609.14

08.8887.40A
08.8887.14A

Perfiles de Alimentación Feed Unit Profiles

1000 mm
06.1638.14

1500 mm
06.1639.14

2000 mm
06.1640.14

2500 mm
06.1641.14

3000 mm
06.1642.14

90° Corner
06.1648.14

Inner Corner
06.1650.14

Outer Corner
06.1651.14

Perfiles Intermedios
Intermediate Profiles
1000 mm
06.1643.14

1500 mm
06.1644.14

2000 mm
06.1645.14

2500 mm
06.1646.14

3000 mm
06.1647.14

Fixed Ceiling Kit
2 Unit Kit
08.8866.14

Adjustable Ceiling Kit
2 Unit Kit
08.8867.14

08.8865.14A

THE RUNNING MAGNET 2.0 SUSPENSION UP&DOWN — PROFILES

Perfiles / Profiles

Carril electro-mecánico para instalaciones suspendidas.

Los elementos lineales en versión Up&Down incluyen iluminación LED indirecta en la parte superior del perfil. Pueden alimentarse con alimentación común o independiente.

Carriles lineales disponibles en dos versiones: perfiles de alimentación, para conexión a driver, y perfiles intermedios. Ambas versiones con longitudes de 1m a 3m.

Tapas incluidas en los perfiles de alimentación.

Accesorios para conexión (cable alimentación 4,2m) y suspensión (cable de acero 4m) a techo incluidos en todos los productos lineales de alimentación o intermedios.

Disponibles esquinas de 90° en el mismo plano (elemento simétrico para esquina izquierda y derecha). No provistos para conexión a driver.

Las esquinas de las versiones Suspendidas del Running Magnet 2.0 no llevan iluminación indirecta. La iluminación indirecta puede ser controlada como un circuito separado si se alimenta con un equipo especial y, en el caso de una instalación DALI, equipada con un equipo opcional de control DALI se debe pedir por separado.

Los perfiles no se pueden cortar.

Electromechanical track for suspended installations.

Linear elements in the Up&Down version include indirect LED illumination in the upper part of the profile. Shared or separate power feed.

Linear tracks available in two versions: power feed profiles for connecting to a driver, and intermediate profiles. Both versions available in lengths from 1m to 3m.

Covers included with the power feed profiles.

Ceiling connection (4.2m feed cable) and suspension (4m steel cable) accessories included in all linear feed or intermediate products.

90° corners in the same plane (symmetrical element for right and left corners). Not provided for connection to the driver.

The corners of the Suspended Running Magnet 2.0 versions are not fitted with indirect illumination. Indirect illumination can be managed as a separate circuit if powered by a dedicated driver and, in the case of the DALI installation, if equipped with a dedicated optional DALI controller. To be ordered separately.

Profiles cannot be cut.

Elementos Lineales / Straight Elements

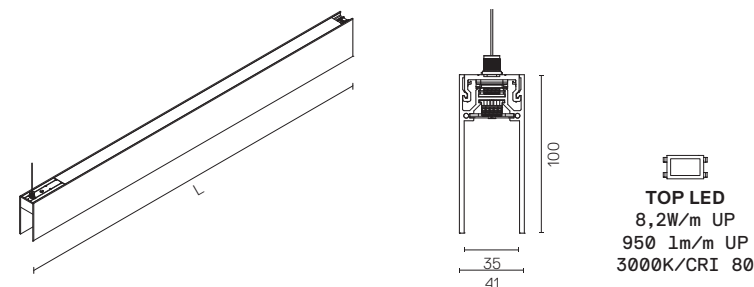

L: 1 m / 1,5 m / 2 m / 2,5 m / 3 m

Esquina 90° / 90° Corner

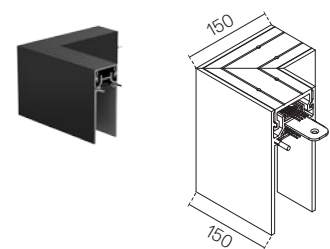

Ver accesorios disponibles.
See available accessories.

Perfiles de Alimentación Feed Unit Profiles

1000 mm
06.1614.40
06.1614.14

1500 mm
06.1615.40
06.1615.14

2000 mm
06.1616.40
06.1616.14

2500 mm
06.1617.40
06.1617.14

3000 mm
06.1618.40
06.1618.14

Perfiles Intermedios Intermediate Profiles

1000 mm
06.1619.40
06.1619.14

1500 mm
06.1620.40
06.1620.14

2000 mm
06.1621.40
06.1621.14

2500 mm
06.1622.40
06.1622.14

3000 mm
06.1623.40
06.1623.14

90° Corner
06.1624.40
06.1624.14

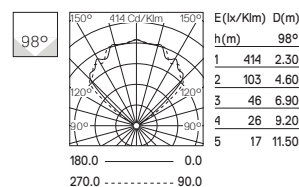

THE RUNNING MAGNET 2.0 SUSPENSION DOWN — PROFILES

Perfiles / Profiles

Carril electro-mecánico para instalaciones suspendidas.

Carriles lineales disponibles en dos versiones: perfiles de alimentación, para conexión a driver, y perfiles intermedios. Ambas versiones con longitudes de 1m a 3m.

Tapas incluidas en los perfiles de alimentación.

Accesorios para conexión (cable alimentación 4,2m) y suspensión (cable de acero 4m) a techo incluidos en todos los productos lineales de alimentación o intermedios.

Disponibles esquinas de 90° en el mismo plano (elemento simétrico para esquina izquierda y derecha), comunes en versiones Surface y Down. Provisos para conexión a driver.

Electromechanical track for suspended installations.

Linear tracks available in two versions: power feed profiles for connecting to a driver, and intermediate profiles. Both versions available in lengths from 1m to 3m.

Covers included with the power feed profiles.

Ceiling connection (4.2m feed cable) and suspension (4m steel cable) accessories included in all linear feed or intermediate products.

90° corners in the same plane (symmetrical element for right and left corners) for the Surface and Down versions. Provided for connection to the driver.

Elementos Lineales / Straight Elements

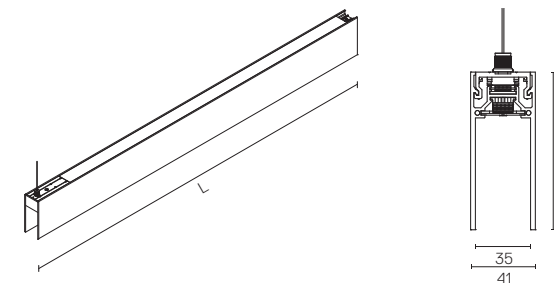

L: 1 m / 1,5 m / 2 m / 2,5 m / 3 m

Esquina 90° / 90° Corner

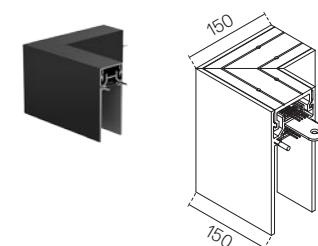

Ver accesorios disponibles.
See available accessories.

Accesorios Accessories

Las tapas van incluidas con todos los perfiles de alimentación. Se deben pedir por separado, solo si la instalación está compuesta por perfiles intermedios y alimentada en las esquinas esquinas, exclusivamente.

Endcaps come complete with all the feed unit profiles. These should only be ordered separately if the installation is exclusively composed of intermediate profiles and fed by corners.

Perfiles de Alimentación Feed Unit Profiles

1000 mm
06.1626.40
06.1626.14

1500 mm
06.1627.40
06.1627.14

2000 mm
06.1628.40
06.1628.14

2500 mm
06.1629.40
06.1629.14

3000 mm
06.1630.40
06.1630.14

90° Corner
06.1610.40
06.1610.14

Perfiles Intermedios Intermediate Profiles

1000 mm
06.1631.40
06.1631.14

1500 mm
06.1632.40
06.1632.14

2000 mm
06.1633.40
06.1633.14

2500 mm
06.1634.40
06.1634.14

3000 mm
06.1635.40
06.1635.14

08.8887.40A
08.8887.14A

THE RUNNING MAGNET 2.0 SUSPENSION — ACCESSORIES

Rosetón de alimentación de superficie. Equipo no incluido, pedir por separado.

Surface rose. Equipment not included. To be ordered separately.



Caja de alimentación de superficie tanto para luz directa como luz directa e indirecta con alojamiento para driver. Equipo 24V/185W incluido.

Surface power supply for direct and indirect lighting with housing for the driver. 24V/185W equipment included.

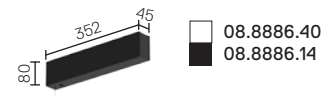

Controlador DALI y equipo 24V/185W para alimentar y controlar tanto la iluminación directa como la indirecta, incluido.

DALI controller and 24V/185W equipment to supply and control both the direct and indirect lighting, included.

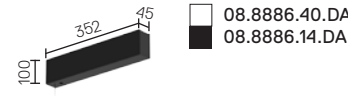

Rosetón de alimentación empotrado. Equipo no incluido, pedir por separado.

Recessed power supply rose. Equipment not included. To be ordered separately.



THE RUNNING MAGNET 2.0 — INSTALLATION PROFILES

RECESSED INSTALLATION

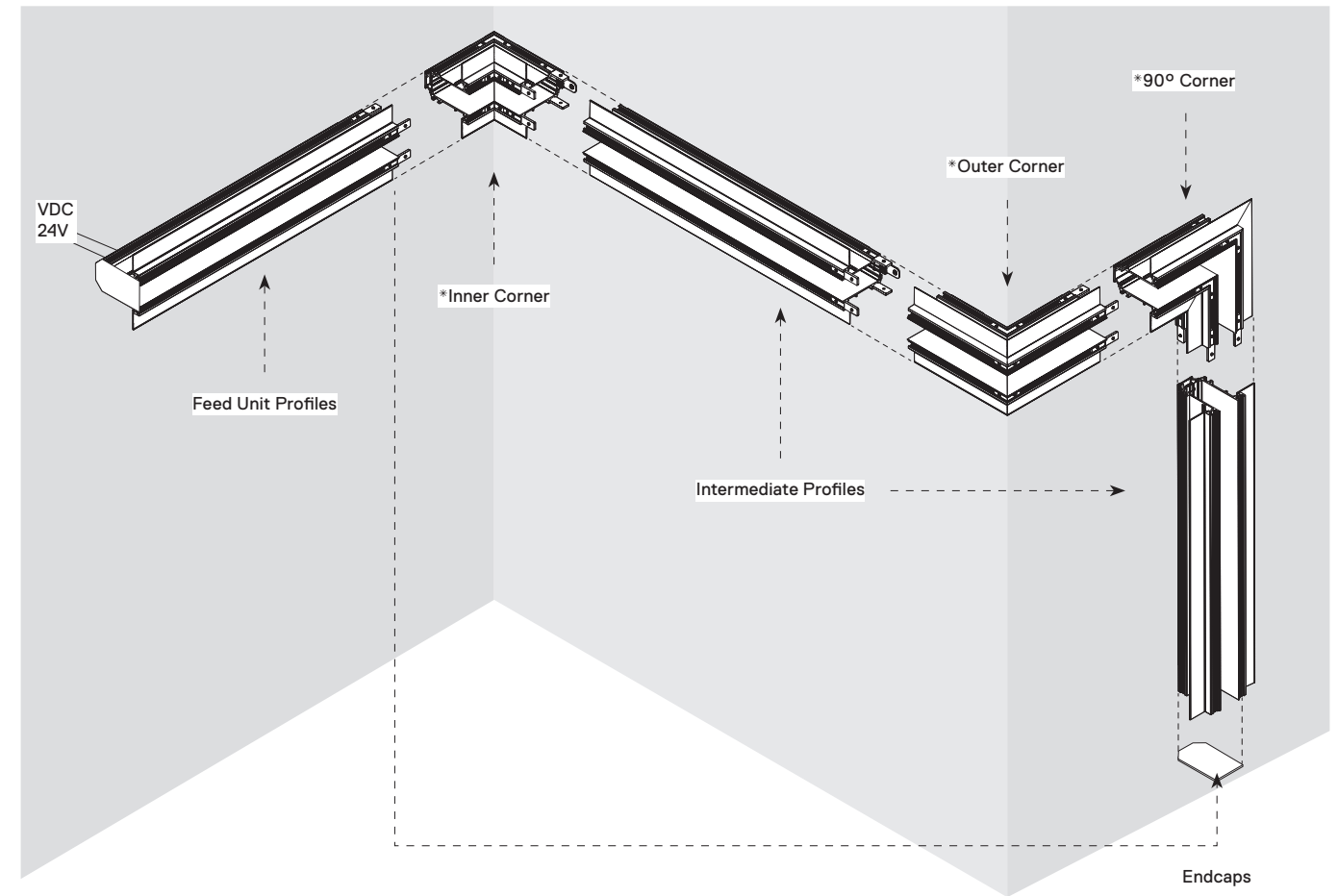

SURFACE INSTALLATION

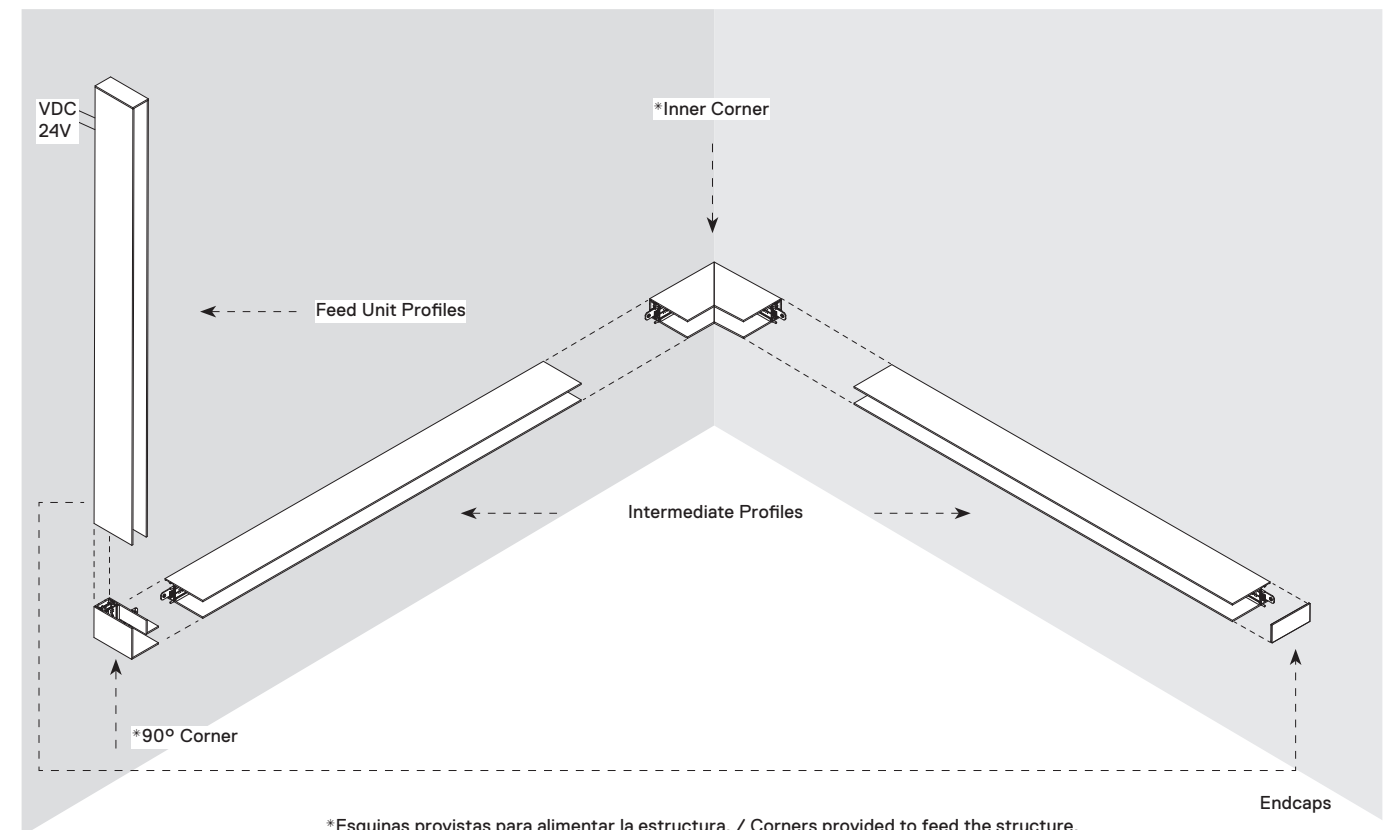

THE RUNNING MAGNET 2.0 — INSTALLATION PROFILES

SUSPENSION INSTALLATION

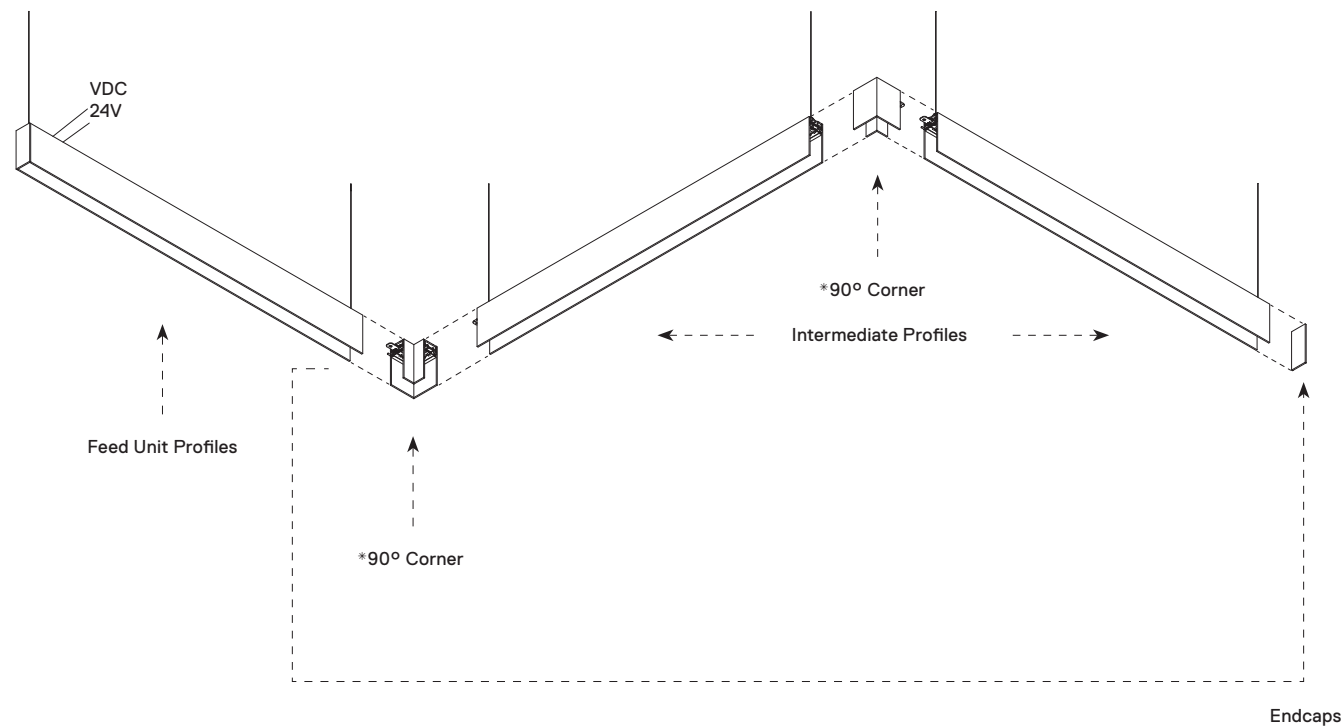

*Esquinas provistas para alimentar la estructura, solo en versión DOWN. / Corners provided to feed the structure, only in the DOWN version.

*Esquinas provistas para alimentar la estructura. / Corners provided to feed the structure.

• ¿Puedo alimentar una estructura directamente desde una esquina sin utilizar un perfil de alimentación?

Sí, las esquinas están preparadas para alimentar una estructura en ambas direcciones sin la necesidad de utilizar un perfil de alimentación. Simplemente se ha de tener en cuenta que se deberán pedir por separado las tapas de los perfiles ya que no están incluidas en las esquinas y perfiles intermedios. Las esquinas en la versión Up&Down no se pueden alimentar.

• ¿Puedo utilizar un perfil de alimentación para alimentar una estructura de superficie desde el centro?

Sí, para alimentar una estructura de superficie desde el centro (en ambas direcciones), se necesitarán dos perfiles de alimentación con dos fuentes de alimentación, una para cada perfil de alimentación, o la misma fuente de alimentación para ambos perfiles de alimentación, respetando las limitaciones eléctricas. La conexión mecánica entre los dos perfiles se puede realizar sin ningún problema.

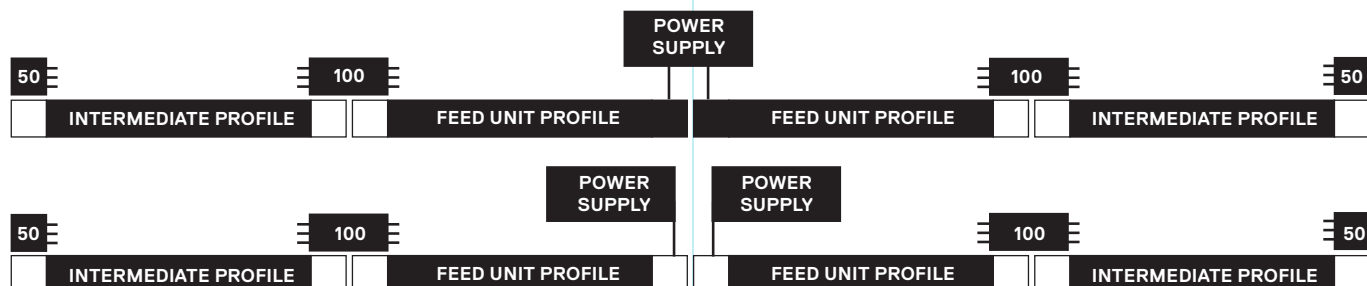

• ¿Puedo cortar un perfil?

Sí, los perfiles se pueden cortar a la medida deseada (excepto en la versión Up&Down). Una vez se corta un perfil se pierde la continuidad eléctrica. Si el perfil cortado no es el que cierra la estructura (en ese caso no se necesita continuidad eléctrica) el siguiente tramo se deberá volver a alimentar con una esquina o un perfil de alimentación.

• Can I feed a structure directly from a corner without using a Feed Unit Profile?

Yes, corners are prepared to feed a structure in both directions without the need for a Feed Unit Profile. Simply remember that you'll have to order the End Cap profiles separately because they are not included in corners and intermediate profiles. Take note that corners in Up&Down versions cannot be fed.

• Can I use a Feed Unit Profile to feed a surface structure from the center?

Yes, to feed a surface structure from the center (in both directions), you'll need to use two Feed Unit Profiles with two power supplies connected, one to each Feed Unit Profile, or connect the same power supply to both Feed Unit Profiles, respecting any potential electrical limitations. The mechanical connection can be made between profiles without any problem.

• Can I cut a profile?

Yes, profiles can be cut to the desired length (except Up&Down version). Once a profile is cut, the electrical continuity is lost. If the cut element is not the one that closes the structure (in that case you don't need electrical continuity) the next section must be fed with a corner or a Feed Unit Profile.

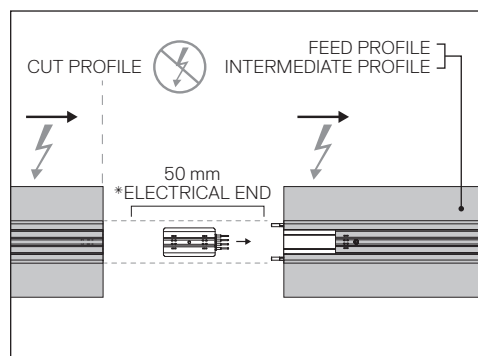
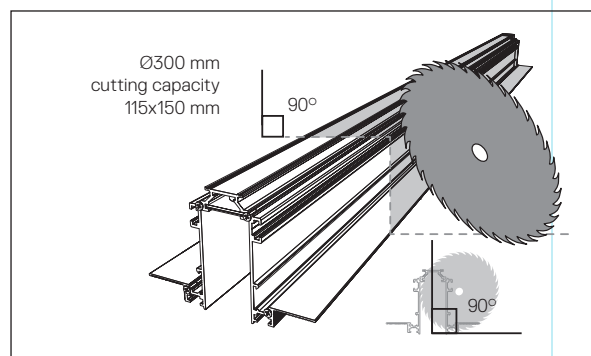

*Incluido en los perfiles de alimentación o endcaps / Included with feed profiles or endcaps.

• ¿Puedo controlar de manera independiente la iluminación directa e indirecta en la versión Up&Down?

Sí, para controlar la iluminación directa e indirecta de forma independiente simplemente se ha de conectar una fuente de alimentación a la conexión de iluminación indirecta y otra a la directa, permitiendo de esta forma controlar las diferentes fuentes de manera independiente. Si se desea usar un sistema de regulación DALI, entonces la fuente de alimentación conectada a la iluminación indirecta tiene que conectarse a un controlador DALI (60.8635).

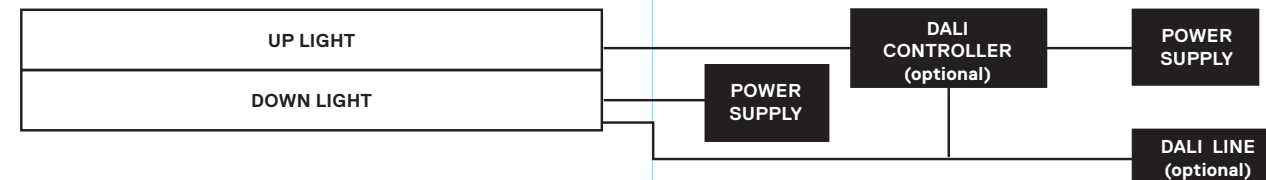

• ¿Puedo controlar de manera independiente las luminarias instaladas en una estructura con un controlador DALI?

Sí, el sistema DALI identificará cada luminaria que se instale individualmente y permitirá su control de manera independiente.

• ¿Necesito la unidad de control dimmable DALI 60.8635 para hacer la estructura DALI?

Las luminarias ya van equipadas con electrónica DALI, por lo que la unidad de control DALI no será necesaria. La unidad de control DALI 60.8635 solo será necesaria para controlar la iluminación indirecta con un sistema DALI en la versión Up&Down.

• ¿Cuál es la distancia máxima permitida entre la fuente de alimentación y el perfil?

Con la fuente de alimentación de 185W (60.0004) de nuestro catálogo, la distancia máxima permitida es:
 . Cable de Ø 1,5mm: 3 metros
 . Cable de Ø 2,5mm: 5 metros

• ¿Cuál es la longitud máxima que se puede alimentar con una fuente de alimentación en una estructura?

La longitud máxima de un perfil que puede alimentarse con una fuente de alimentación es 8m.

• ¿Puedo utilizar una fuente de alimentación diferente - menos potente?

Toda la información publicada en nuestra web, catálogo e instrucciones de instalación se ajusta a los tests realizados con nuestra fuente de alimentación de 185W (60.0004) recomendada para nuestros productos. De todas formas, se puede utilizar una fuente de alimentación diferente para alimentar los perfiles, pero teniendo en cuenta las limitaciones eléctricas que debe cumplir. Debe ser una fuente de alimentación de 24V con una corriente eléctrica máxima de 8A.

• Can I independently control the Up Light and the Down Light in the Up&Down version?

Yes, to control the Up Light and Down Light independently you just have to connect one power supply to the down electrical connector and another one to the up electrical connector. This allows you to manage the different light sources independently. If you want to use a DALI Dimmable system for the Up Light and the Down Light, then the power supply connected to Up Light must be connected to a Dali controller (60.8635).

• Can I independently control the luminaires installed in the structure with a DALI controller?

Yes, the DALI system will identify each luminaire installed in the profile with a unique address, and will allow you to independently manage each one.

• Do I need the Dimmable Dali controller 60.8635 to make the DALI structure?

The luminaires to be installed in the track are already equipped with Dali electronic, so a Dali controller is not required for these. The 60.8635 DALI Controller is only required to make the Up indirect Light controllable with a DALI system in the Up&Down version.

• What is the maximum distance allowed between the driver and the profile?

With the 185W power supply (60.0004) in our catalogue, the maximum distance allowed is:
 . Ø 1.5mm cable: 3 meters
 . Ø 2.5mm cable: 5 meters

• What is the maximum length that can be fed with one Power Supply?

The maximum profile length that can be fed with a power supply is 8m.

• Can I use a different, less powerful Power Supply?

All the information published on our website, and in our catalogue and installation instructions sheets is adjusted to the tests we perform with our 185W power supply (60.0004), which we recommend for our products. However, a different power supply can be used to feed the profiles but the electrical limitations that it will have to accomplish should be taken into account. It should be a 24V power supply with a maximum electric current of 8A.

THE RUNNING MAGNET 2.0 — LIGHT MODULES

LIGHT STRIPE



TOP LED
25W/m
2266 lm/m
2700K/CRI 80

25W/m
2333 lm/m
3000K/CRI 80



300 mm - 2700K
■ 03.6311.14
Dali Version
■ 03.6311.14ADA

300 mm - 3000K
■ 03.6310.14
Dali Version
■ 03.6310.14ADA

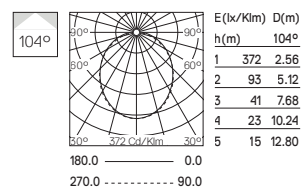

Módulo de iluminación LED de luz difusa para ser instalado en el sistema The Running Magnet 2.0. Tapas opalinas para crear líneas de luz continuas incluidas.

Diffused LED light module to be installed in The Running Magnet 2.0 System. Opaline endcaps to create continuous lines of light included.

L (mm)	Power (W)	Luminous flux of luminaire up to (lm)	
		2700K	3000K
300	7,5	680	700
600	15	1360	1400
900	22,5	2040	2100
1200	30	2720	2800
1500	37,5	3400	3500

600 mm - 2700K
■ 03.6321.14
Dali Version
■ 03.6321.14ADA

600 mm - 3000K
■ 03.6320.14
Dali Version
■ 03.6320.14ADA

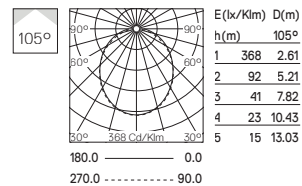

900 mm - 2700K
■ 03.6331.14
Dali Version
■ 03.6331.14ADA

900 mm - 3000K
■ 03.6330.14
Dali Version
■ 03.6330.14ADA

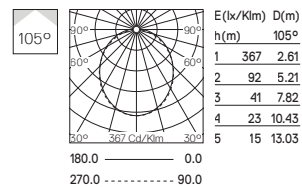

1200 mm - 2700K
■ 03.6341.14
Dali Version
■ 03.6341.14ADA

1200 mm - 3000K
■ 03.6340.14
Dali Version
■ 03.6340.14ADA

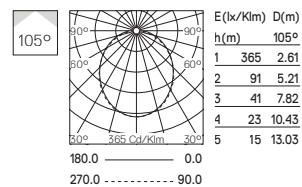

1500 mm - 2700K
■ 03.6351.14
Dali Version
■ 03.6351.14ADA

1500 mm - 3000K
■ 03.6350.14
Dali Version
■ 03.6350.14ADA

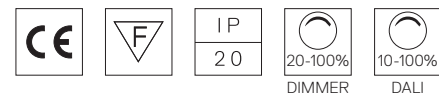
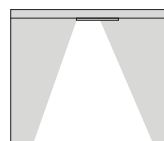
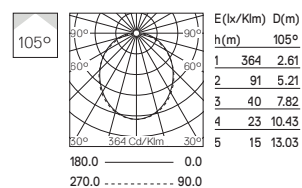

LED INCL.
NOT REPLACEABLE

THE RUNNING MAGNET 2.0 — LIGHT MODULES

SPOT MODULE



POWER LED
8W
560 lm
2700K/CRI 90

8W
600 lm
3000K/CRI 90

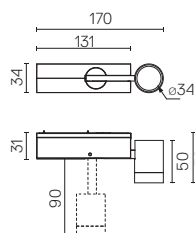

Módulo de iluminación LED de acento para ser instalado en el sistema The Running Magnet 2.0. Convertidor electrónico de corriente DC/DC incorporado.

2700K
■ 03.6303.14A
Dali Version
■ 03.6303.14ADA

3000K
■ 03.6302.14A
Dali Version
■ 03.6302.14ADA

Accent lighting LED module to be installed in The Running Magnet 2.0 System. Built-in DC/DC electronic voltage converter.

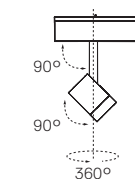

Ver accesorios disponibles.
See available accessories.

Spot Module No DALI:
Máximo 21 spots para un mismo driver. /
Maximum 21 spots for a single driver.

Spot Module DALI:
Máximo 14 spots para un mismo driver. /
Maximum 14 spots for a single driver.

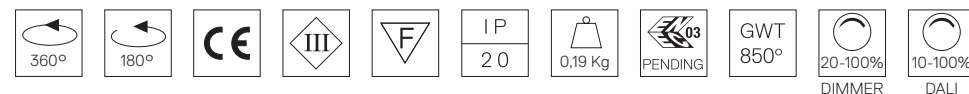
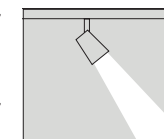

Máximo 64 spots para un mismo controlador DALI.

Maximum 64 spots for a single DALI controller.

LED INCL.
NOT REPLACEABLE

Accesorios Accessories

Aro exterior apantallador para spot module Running Magnet 2.0 realizado en aluminio y acabado en negro, para un incremento del confort visual.



08.8427.14

Screening external ring for Running Magnet 2.0 spot module in aluminium with a black finish to enhance the visual comfort.

SPOT 120



POWER LED
12,5W
985 lm
2700K/CRI 90

12,5W
1060 lm
3000K/CRI 90

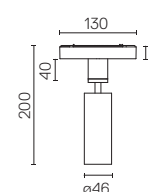

Módulo de iluminación LED de acento para ser instalado en el sistema The Running Magnet 2.0. Convertidor electrónico de corriente DC/DC incorporado.

2700K
■ 03.6285.40
Dali Version
■ 03.6285.40.DA

3000K
■ 03.6284.40
Dali Version
■ 03.6284.40.DA

Accent lighting LED module to be installed in The Running Magnet 2.0 System. Built-in DC/DC electronic voltage converter.

2700K
■ 03.6286.40
Dali Version
■ 03.6286.40.DA

3000K
■ 03.6287.40
Dali Version
■ 03.6287.40.DA

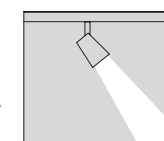

Spot Module No DALI:
Máximo 14 spots para un mismo driver. /
Maximum 14 spots for a single driver.

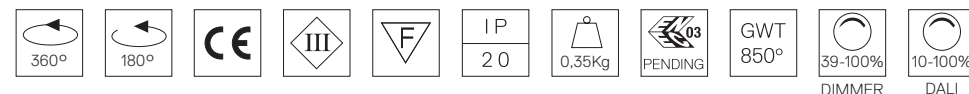

33°
MEDIUM

LED INCL.
NOT REPLACEABLE

THE RUNNING MAGNET 2.0 — LIGHT MODULES

MULTI SPOT 4



POWER LED
10W
4X210 1m
2700K/CRI 90
3000K/CRI 90

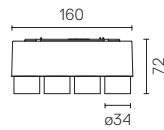

Módulo de iluminación LED de acento para ser instalado en el sistema The Running Magnet 2.0. Convertidor electrónico de corriente DC/DC incorporado.

2700K
■ 03.6305.14
Dali Version
■ 03.6305.14.DA

3000K
■ 03.6306.14
Dali Version
■ 03.6306.14.DA

Accent lighting LED module to be installed in The Running Magnet 2.0 System. Built-in DC/DC electronic voltage converter.

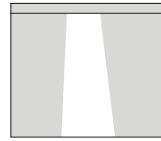

Ver accesorios disponibles.
See available accessories.



LED INCL.
NOT REPLACEABLE

STRING LIGHT SPHERE



LED ARRAY
17W
1785 1m
2700K/CRI 90

17W
1870 1m
3000K/CRI 90

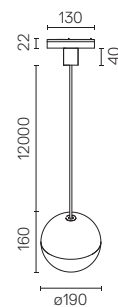

Módulo de iluminación LED general para ser instalado en el sistema The Running Magnet 2.0. Convertidor electrónico de corriente DC/DC incorporado.

2700K
■ 03.6295.14
Dali Version
■ 03.6295.14.DA

3000K
■ 03.6296.14
Dali Version
■ 03.6296.14.DA

General lighting LED module to be installed in The Running Magnet 2.0 System. Built-in DC/DC electronic voltage converter.



STRING LIGHT CONE



LED ARRAY
17W
1785 1m
2700K/CRI 90

17W
1870 1m
3000K/CRI 90

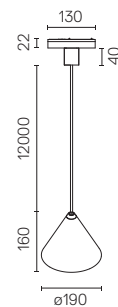

2700K
■ 03.6297.14
Dali Version
■ 03.6297.14.DA

3000K
■ 03.6298.14
Dali Version
■ 03.6298.14.DA



Spot Module No DALI:
Máximo 9 spots para un mismo driver. /
Maximum 9 spots for a single driver.



LED INCL.
NOT REPLACEABLE

THE RUNNING MAGNET 2.0 — LIGHT MODULES

MINI GLO-BALL



POWER LED
7W
800 1m
2700K/CRI 80

7W
880 1m
3000K/CRI 80

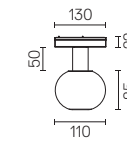

Módulo de iluminación LED de acento para ser instalado en el sistema The Running Magnet 2.0. Convertidor electrónico de corriente DC/DC incorporado.

2700K
■ 03.6260.14B
Dali Version
■ 03.6260.14.DA

3000K
■ 03.6261.14B
Dali Version
■ 03.6261.14.DA

Accent lighting LED module to be installed in The Running Magnet 2.0 System. Built-in DC/DC electronic voltage converter.



MINI GLO-BALL S



POWER LED
3,5W
400 1m
2700K/CRI 80

3,5W
440 1m
3000K/CRI 80

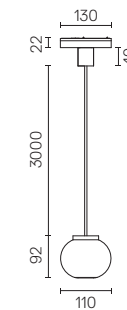

2700K
■ 03.6262.14B
Dali Version
■ 03.6262.14.DA

3000K
■ 03.6263.14B
Dali Version
■ 03.6263.14.DA



Spot Module No DALI:
Máximo 21 spots para un mismo driver. /
Maximum 21 spots for a single driver.

Spot Module DALI:
Máximo 14 spots para un mismo driver. /
Maximum 14 spots for a single driver.

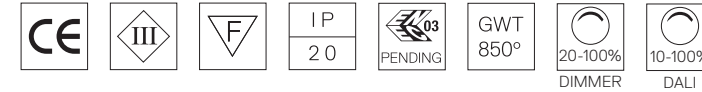
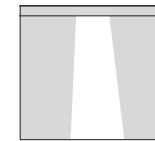

LED INCL.
NOT REPLACEABLE

FIND ME 1 SUSPENSION



POWER LED
8W
560 1m
2700K/CRI 90

8W
600 1m
3000K/CRI 90

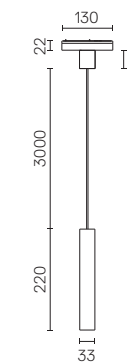

Módulo de iluminación LED de acento para ser instalado en el sistema The Running Magnet 2.0. Convertidor electrónico de corriente DC/DC incorporado.

2700K
■ 03.6272.30C
■ 03.6272.06C
■ 03.6272.14C
Dali Version
■ 03.6272.30CDA
■ 03.6272.06CDA
■ 03.6272.14CDA

Accent lighting LED module to be installed in The Running Magnet 2.0 System. Built-in DC/DC electronic voltage converter.

3000K
■ 03.6273.30C
■ 03.6273.06C
■ 03.6273.14C
Dali Version
■ 03.6273.30CDA
■ 03.6273.06CDA
■ 03.6273.14CDA

Spot Module No DALI:
Máximo 21 spots para un mismo driver. /
Maximum 21 spots for a single driver.

Spot Module DALI:
Máximo 14 spots para un mismo driver. /
Maximum 14 spots for a single driver.

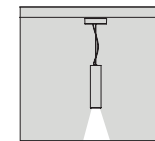

LED INCL.
NOT REPLACEABLE



THE RUNNING MAGNET 2.0 — LIGHT MODULES

ANTHONY SPOT TRACK



LED ARRAY
17W
1785 lm
2700K/CRI 90

17W
1870 lm
3000K/CRI 90

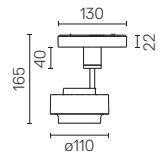

Módulo de iluminación LED de acento para ser instalado en el sistema The Running Magnet 2.0. Convertidor electrónico de corriente DC/DC incorporado.

Accent lighting LED module to be installed in The Running Magnet 2.0 System. Built-in DC/DC electronic voltage converter.

2700K
03.6277.40
03.6277.14 Dali Version
03.6277.40.DA
03.6277.14.DA

3000K
03.6274.40
03.6274.14 Dali Version
03.6274.40.DA
03.6274.14.DA

2700K
03.6278.40
03.6278.14 Dali Version
03.6278.40.DA
03.6278.14.DA

3000K
03.6275.40
03.6275.14 Dali Version
03.6275.40.DA
03.6275.14.DA

2700K
03.6279.40
03.6279.14 Dali Version
03.6279.40.DA
03.6279.14.DA

3000K
03.6276.40
03.6276.14 Dali Version
03.6276.40.DA
03.6276.14.DA



Ver accesorios disponibles.
See available accessories.

Spot Module No DALI:
Máximo 9 spots para un mismo driver. /
Maximum 9 spots for a single driver.

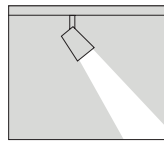

360° 180° CE III F IP 20 0.36 Kg PENDING GWT 850° 30-100% DIMMER 10-100% DALI

LED INCL.
NOT REPLACEABLE

THE RUNNING MAGNET 2.0

ACCESORIOS / ACCESSORIES

Accesorios
Accessories

Spot Module & Multi Spot 4

Lente frosted medium.
Accesorio de óptica Flood.

Frosted medium lens.
Flood lens accessory.



08.8760.00

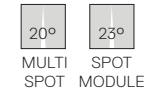

Lente frosted medium.
Accesorio de óptica Wide Flood.

Frosted medium lens.
Wide Flood lens accessory.



08.8761.00

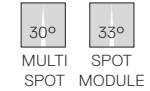

Lente elíptica.
Elliptical lens.



08.8759.00

Anthony Spot Track

Lente elíptica.
Elliptical lens.



08.8418.68A

Honeycomb.
Honeycomb.



08.8419.14A

Equipos
Drivers

Fuente de alimentación LED para instalación remota en cuadro eléctrico 24V/185W. Para evitar problemas de sobrecarga se recomienda instalar una fuente de alimentación cada 185W.



60.0004

LED power supply source for remote installation in 24V/185W electric control panel. To avoid problems of overload it is recommended to install a power source every 185W.

The Running Magnet 2.0 Up&Down version

Transformador electrónico de tensión constante (24V) para LED. 100/240V.



60W
60.8496

Electronic transformer with constant voltage (24V) for LED. 100/240V.

Unidad de control dimable Dali de 1 canal para la regulación de módulos LED, para equipos de 24V. No incluye fuente de alimentación.



60.8635

Dimmable Dali control unit with 1 channel for 24V LED modules. Power supply not included.



Sistema de fijación magnética que permite la instalación de los módulos de luz sin cables.

Magnetic fixture system that permits installing light modules without cable.

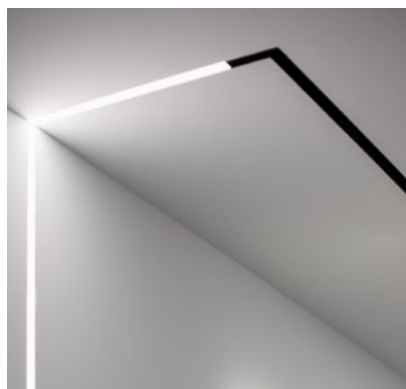

Gran adaptabilidad al espacio al disponer de corners pared-pared (mismo plano / distinto plano) y pared-techo.

Adapts very well to the space as it has wall-wall (same plane / different plane) and wall-ceiling corner pieces.

Detalles de Aplicación
Application Details

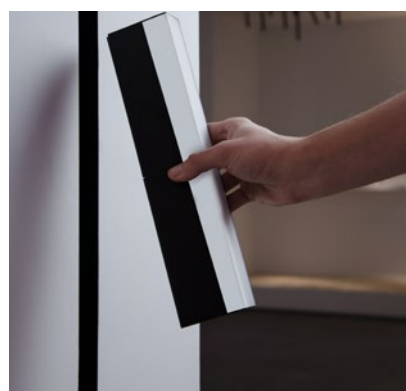
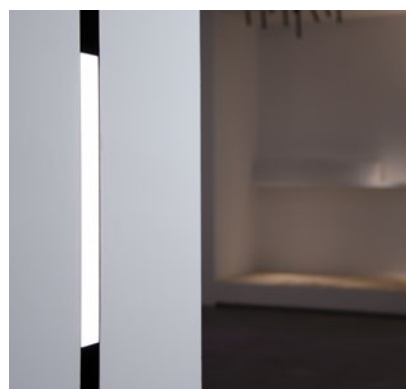

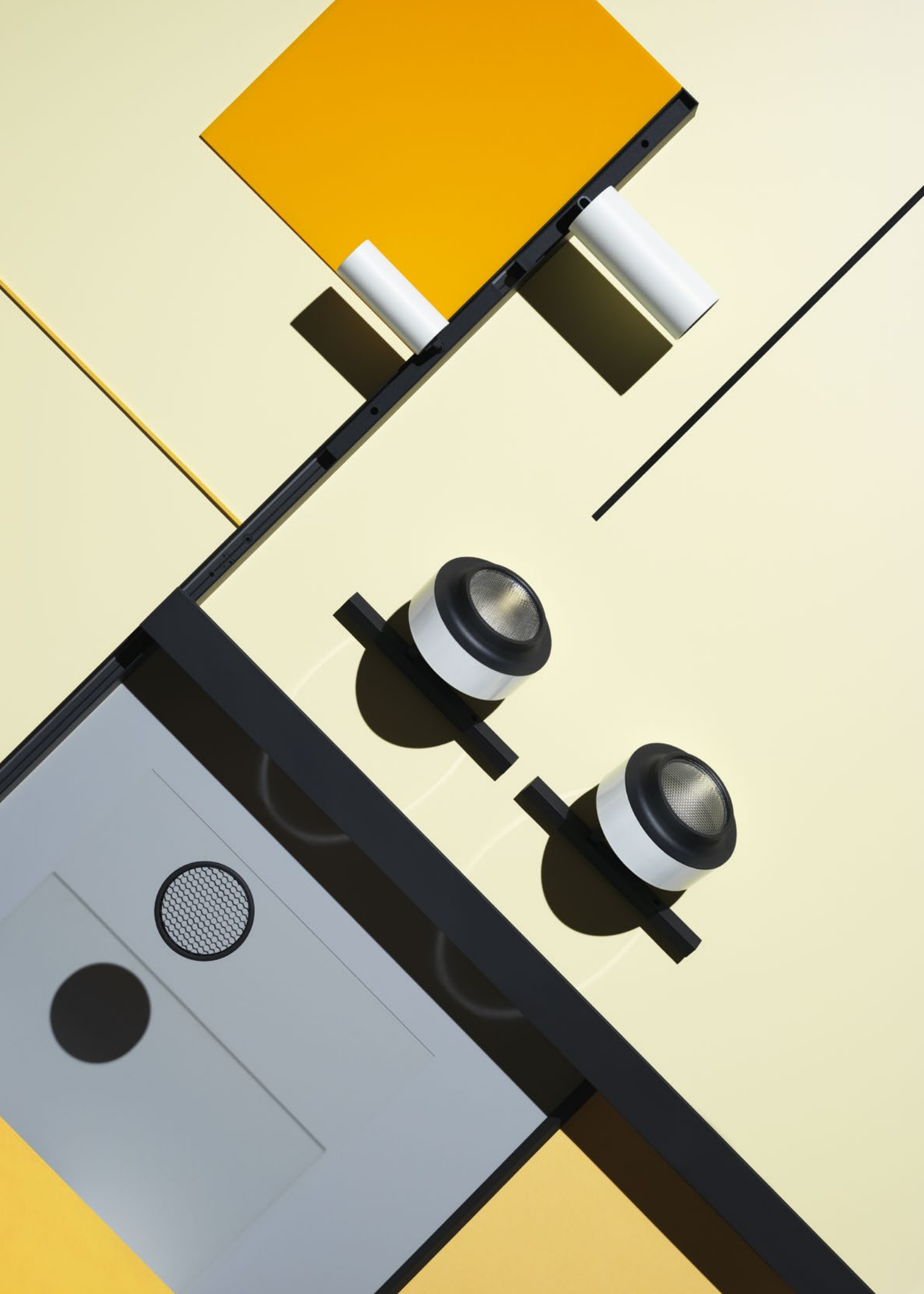

THE TRACKING MAGNET

La dimensión más compacta posible en un carril con luminarias de instalación magnética. Instalación con el mínimo impacto en la arquitectura, empotrada, de superficie o suspendida. Luminarias LED de diseño minimalista y elegante. Flexibilidad y adaptabilidad a necesidades en evolución continua.

THE TRACKING MAGNET

The most compact measurements in a rail with magnetically-installed luminaires. A flush, surface or suspended installation with a minimum impact on architecture. Minimalist and elegant LED luminaires. Flexibility and adaptability to the ever-changing needs.

DESIGNED BY FLOS ARCHITECTURAL



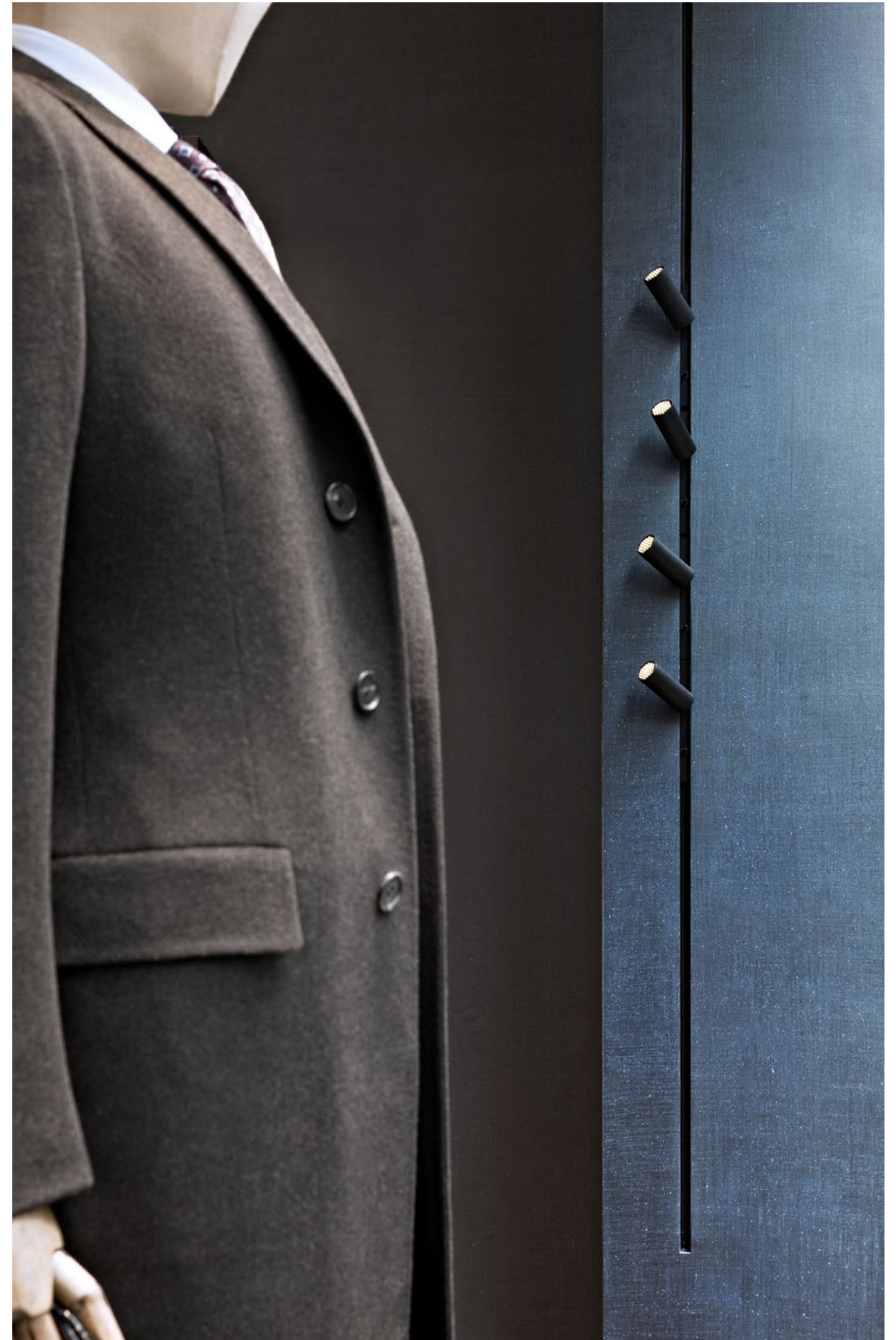

Descripción

Innovador sistema de iluminación para interior en versiones superficie, suspendida o empotrada en pared/techo de cartón yeso. Compuesto por perfilería magnética donde se posicionan, mediante sistema de fijación magnética, módulos de iluminación.

Todos los perfiles estructurales del Tracking Magnet han sido fabricados con perfilería de aluminio extruido en blanco o negro, provistos de pistas eléctricas de grafito alimentadas a 24V, sobre las cuales se instalan, mediante un sistema de fijación magnética, las luminarias LED.

La versión suspendida también está disponible para luz indirecta.

La familia Tracking Magnet se completa con luminarias decorativas de diferentes ópticas acorde a la mayoría de las colecciones Flos.

Las luminarias decorativas incorporan un sistema de fijación magnética que permite una completa movilidad y flexibilidad. Todas las luminarias disponen de un potenciómetro instalado para regular la intensidad luminosa.

Sistema Óptico

- Spot tracking 90: spot.
- Spot tracking 120: spot, flood.
- Anthony spot: spot, medium, flood.

Unidades de Alimentación

Fuente de alimentación remota de 24V no incluida.

Accesorios

Para el módulo de iluminación Anthony spot existen lentes elípticas y elementos apantalladores.

Para los módulos de iluminación Spot tracking los accesorios van incorporados en el producto.

Las versiones Suspension y Suspension Up&Down ofrecen dos sistemas de suspensión que deben pedirse por separado: varilla rígida y cable de acero.

Información Adicional

Únicamente instalable en superficies de cartón-yeso de 12,5mm de espesor para la versión Recessed.

The Tracking Magnet es un sistema eléctrico alimentado a 24V y limitado a una corriente máxima de 8A y 185W para evitar sobrecargas.

Cada vez que completemos los 185W deberemos realizar una nueva conexión a driver.

Índice de protección IP20.

Instalable sobre superficies normalmente inflamables.

Cumplimiento de Normativa y Marcas de Calidad

Luminaria conforme con la Normativa Técnica Europea EN60598-1 y partes segundas.

Description

Innovative lighting system for indoor use, for surface, suspended or recessed mounting on plasterboard walls or ceilings, comprising a series of magnetic tracks that house the LED lighting modules.

The profile of all The Tracking Magnet structural tracks is extruded aluminum, painted black or white, housing a graphite electric track fed at 24V, on which all magnetic luminaires are installed simply by insertion.

Suspended track is also available with the option of indirect lighting.

Like most Flos collections, the Tracking Magnet family has decorative luminaires with different optics.

The decorative luminaires have an integrated magnetic attachment system for full mobility and flexibility. All the luminaires have a potentiometer for brightness control.

Optic system

- Spot tracking 90: spot.
- Spot tracking 120: spot, flood.
- Anthony spot: spot, medium, flood.

Power Supply

Remote 24V power supply not included.

Accessories

The Anthony spot illumination module offers elliptical lenses and cut-off elements.

Accessories for the Spot tracking illumination modules come with the product.

Suspension and Suspension Up&Down versions offers two different suspension systems to be ordered separately: rigid rod and steel cable.

Additional Information

The Recessed version can only be installed on 12.5 mm thick plasterboard surfaces.

The Tracking Magnet is a 24V electrical system limited to a maximum power current of 8A and 185W to avoid overloads.

After every 185W make a new connection with a driver. IP20 protection grade.

Suitable for installation on normally inflammable surfaces.

Compliance of Standards and Quality Marks

EN60598-1 European Technical Standards and any subsequent additions.

LIGHT MODULES

LIGHT STRIPE



TOP LED
8,3W/m
700 lm/m
2700K/CRI 80
3000K/CRI 80

ANTHONY SPOT TRACK

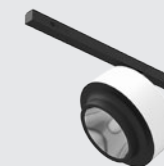

LED ARRAY
17W
1785 lm
2700K/CRI 90
17W
1870 lm
3000K/CRI 90

ANTHONY SPOT CEILING



LED ARRAY
13,5W
1500 lm
2700K/CRI 90
13,5W
1600 lm
3000K/CRI 90

SPOT TRACKING 50



POWER LED
4,2W
410 lm
2700K/CRI 90
4,2W
440 lm
3000K/CRI 90

SPOT TRACKING 90



POWER LED
9,6W
850 lm
2700K/CRI 90
9,6W
900 lm
3000K/CRI 90

SPOT TRACKING 120



POWER LED
12,5W
985 lm
2700K/CRI 90
12,5W
1060 lm
3000K/CRI 90

EASY SPOT TRACKING



LED
QR-CBC 51
GX5.3
MAX 8W

Colores
Colours

RECESSED



14 Negro
14 Black

SURFACE



40 Blanco
40 White

SUSPENSION
UP&DOWN / DOWN



05 Cromo
05 Chrome

14 Negro
14 Black

THE TRACKING MAGNET RECESSED — PROFILES

Perfiles / Profiles

Carril electro-mecánico para instalaciones empotradas en techos/paredes de cartón yeso. Carriles lineales disponibles en dos versiones: perfiles de alimentación, para conexión a driver, y perfiles intermedios. Ambas versiones con longitudes de 1m a 3m. Tapas incluidas en los perfiles de alimentación. Disponibles esquinas de 90° en el mismo plano (elemento simétrico para esquina izquierda y derecha), esquinas simétricas de 90° en distinto plano en interior y exterior. Provistos para conexión a driver. Kits de sujeción, fijo o ajustable, disponibles (opcional). Los Kits de sujeción a techo permiten la instalación sin necesidad de perfiles de aluminio de sujeción. Recomendado para instalaciones en las que se puede instalar el perfil Tracking Magnet antes que el falso techo de cartón yeso.

Electromechanical track for recessed installation in plasterboard ceilings and walls. Linear tracks available in two versions: power feed profiles for connecting to a driver, and intermediate profiles. Both versions available in lengths from 1m to 3m. Covers included with the power feed profiles. 90° corners available in the same plane (symmetrical element for left and right corners), symmetrical 90° inner and outer corners in different planes. For connection to the driver. Permanent or adjustable fastening kits available (optional). The fastening kits for the roof permit installing without using aluminium fastening profiles. Recommended for installations where the Tracking Magnet cannot be installed before the suspended plasterboard ceiling.

Elementos Lineales / Straight Elements

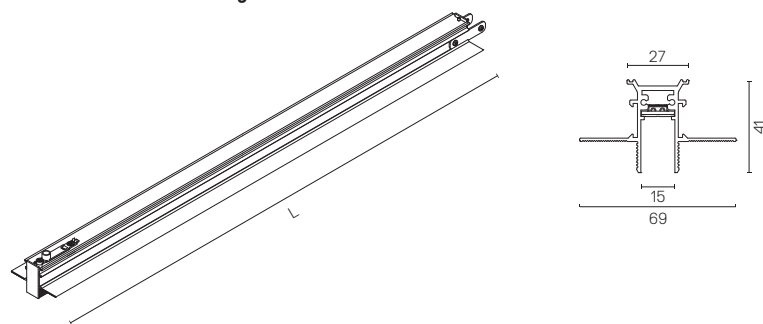

L: 1 m / 1,5 m / 2 m / 2,5 m / 3 m

Esquina 90° / 90° Corner

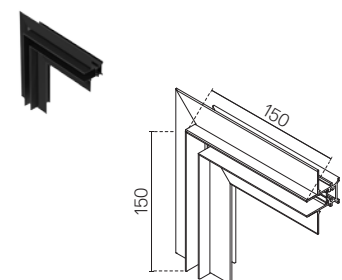

Esquina Interior / Inner Corner

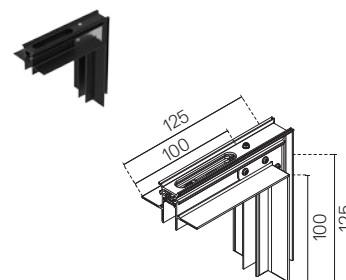

Esquina Exterior / Outer Corner

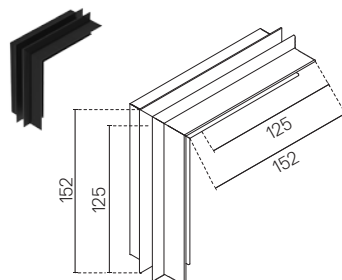

Kit de Sujeción a Techo Fijo / Kit Fixed Ceiling (optional)

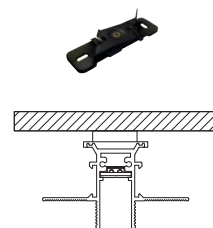

Kit de 2 Unidades
2 Unit Kit

Kit de Sujeción a Techo Ajustable / Kit Adjustable Ceiling (optional)

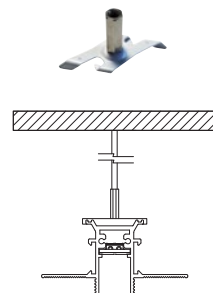

Kit de 2 Unidades
2 Unit Kit

Profile (mm)	Quantities Ceiling Kit (units)
1000/1500	2
2000/2500	3
3000	4

Accesorios Accessories

Las tapas van incluidas con todos los perfiles de alimentación. Se deben pedir por separado, solo si la instalación está compuesta por perfiles intermedios y alimentada en las esquinas, exclusivamente.

Endcaps come complete with all the feed unit profiles. These should only be ordered separately if the installation is exclusively composed of intermediate profiles and fed by corners.



THE TRACKING MAGNET SURFACE — PROFILES

Perfiles / Profiles

Carril electro-mecánico para instalaciones en superficie. Carriles lineales disponibles en dos versiones: perfil de alimentación, para conexión a driver, y perfiles intermedios. Ambas versiones con longitudes de 1m a 3m. Tapas incluidas en los perfiles de alimentación. Accesorios de fijación incluidos en todos los productos. Disponibles esquinas de 90° en el mismo plano (elemento simétrico para esquina izquierda y derecha) y esquinas simétricas de 90° en distinto plano en interior. Provistos para conexión a driver.

Electromechanical track for surface-mounting. Linear tracks available in two versions: power feed profiles for connecting to a driver, and intermediate profiles. Both versions available in lengths from 1m to 3m. Covers included with the power feed profiles. Attachment accessories included with all products. 90° corners available in the same plane (symmetrical element for left and right corner) and 90° symmetrical internal corners in a different plane. For connection to the driver.

Elementos Lineales / Straight Elements

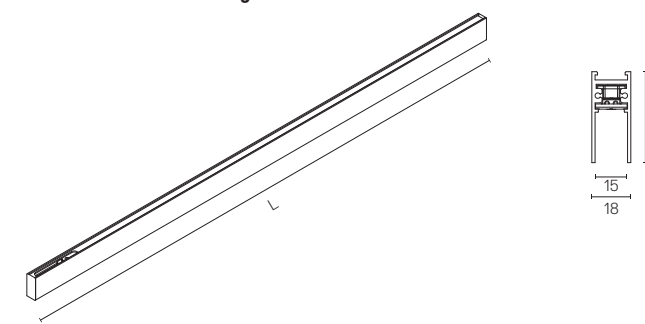

L: 1 m / 1,5 m / 2 m / 2,5 m / 3 m

Esquina 90° / 90° Corner

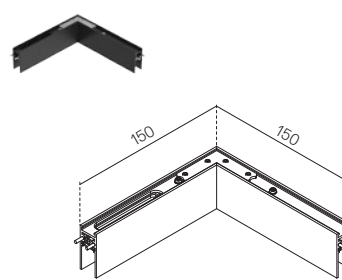

Esquina Interior / Inner Corner

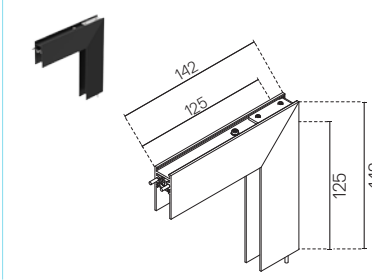

Accesorios Accessories

Las tapas van incluidas con todos los perfiles de alimentación. Se deben pedir por separado, solo si la instalación está compuesta por perfiles intermedios y alimentada en las esquinas, exclusivamente.

Endcaps come complete with all the feed unit profiles. These should only be ordered separately if the installation is exclusively composed of intermediate profiles and fed by corners.



Perfiles de Alimentación Feed Unit Profiles

1000 mm
06.1500.40
06.1500.05
06.1500.14

1500 mm
06.1501.40
06.1501.05
06.1501.14

2000 mm
06.1502.40
06.1502.05
06.1502.14

2500 mm
06.1503.40
06.1503.05
06.1503.14

3000 mm
06.1504.40
06.1504.14

90° Corner
06.1510.40
06.1510.05
06.1510.14

Inner Corner
06.1512.40
06.1512.05
06.1512.14

Perfiles Intermedios Intermediate Profiles

1000 mm
06.1505.40
06.1505.05
06.1505.14

1500 mm
06.1506.40
06.1506.05
06.1506.14

2000 mm
06.1507.40
06.1507.05
06.1507.14

2500 mm
06.1508.40
06.1508.05
06.1508.14

3000 mm
06.1509.40
06.1509.14

08.8890.40A
08.8890.05A
08.8890.14A

08.8890.14A

Perfiles / Profiles

Carril electro-mecánico para instalaciones suspendidas.
 Los elementos lineales en versión Up&Down incluyen iluminación LED indirecta en la parte superior del perfil. El carril magnético y la iluminación Up se tienen que alimentar con el mismo equipo.
 Carriles lineales disponibles en dos versiones: perfiles de alimentación, para conexión a driver, y perfiles intermedios. Ambas versiones con longitudes de 1m a 3m. Los perfiles no se pueden cortar.
 Tapas incluidas en los perfiles de alimentación.
 Cable de alimentación de 3 m incluido en todos los productos lineales de alimentación.
 Accesorios de suspensión (cable de acero y varillas) se deben pedir por separado.
 Disponibles esquinas de 90° en el mismo plano (elemento simétrico para esquina izquierda y derecha), comunes en versiones Up&Down y Down. No provistos para conexión a driver.
 Las esquinas de las versiones Suspendidas del Tracking Magnet no llevan iluminación indirecta. La iluminación indirecta se controla con circuito común a la luz directa.

Electromechanical track for suspended installations.
 Linear elements in the Up&Down version include indirect LED illumination at the top of the profile. Shared power feed between up light and magnetic track.
 Linear tracks available in two versions: power feed profiles for connecting to a driver, and intermediate profiles. Both versions available in lengths from 1m to 3m. Profiles cannot be cut.
 Covers included with the power feed profiles.
 3m feed cable included in all linear feed products. Suspension accessories (steel cable or rod) to be ordered separately.
 90° corners in the same plane (symmetrical element for right and left corners) for the Up&Down and Down versions. Not provided for connection to the driver.
 The corners of hanging elements of the Tracking Magnet are not fitted with indirect lighting. Indirect illumination is controlled through a common circuit with the direct light.

Elementos Lineales / Straight Elements

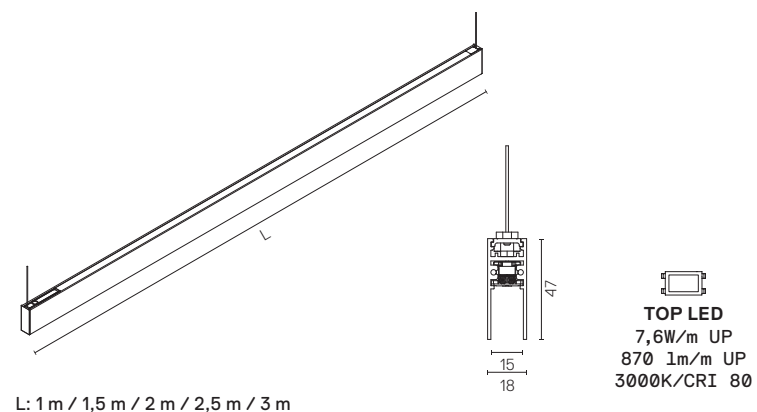

Esquina 90° / 90° Corner

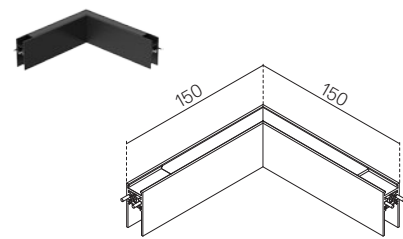

Ver accesorios disponibles.
 See available accessories.

Perfiles de Alimentación
 Feed Unit Profiles

- 1000 mm
- 06.1514.40A
- 06.1514.05A
- 06.1514.14A

- 1500 mm
- 06.1515.40A
- 06.1515.05A
- 06.1515.14A

- 2000 mm
- 06.1516.40A
- 06.1516.05A
- 06.1516.14A

- 2500 mm
- 06.1517.40A
- 06.1517.05A
- 06.1517.14A

- 3000 mm
- 06.1518.40A
- 06.1518.14A

Perfiles Intermedios
 Intermediate Profiles

- 1000 mm
- 06.1519.40A
- 06.1519.05A
- 06.1519.14A

- 1500 mm
- 06.1520.40A
- 06.1520.05A
- 06.1520.14A

- 2000 mm
- 06.1521.40A
- 06.1521.05A
- 06.1521.14A

- 2500 mm
- 06.1522.40A
- 06.1522.05A
- 06.1522.14A

- 3000 mm
- 06.1523.40A
- 06.1523.14A

- 90° Corner
- 06.1524.40A
- 06.1524.05A
- 06.1524.14A

Perfiles / Profiles

Carril electro-mecánico para instalaciones suspendidas.
 Carriles lineales disponibles en dos versiones: perfiles de alimentación, para conexión a driver, y perfiles intermedios. Ambas versiones con longitudes de 1m a 3m. Los perfiles no se pueden cortar.
 Tapas incluidas en los perfiles de alimentación.
 Cable de alimentación de 3m incluido en todos los productos lineales de alimentación.
 Accesorios de suspensión (cable de acero y varillas) se deben pedir por separado.
 Disponibles esquinas de 90° en el mismo plano (elemento simétrico para esquina izquierda y derecha), comunes en versiones Up&Down y Down. No provistos para conexión a driver.
 Electromechanical track for suspended installations.
 Linear tracks available in two versions: power feed profiles for connecting to a driver, and intermediate profiles. Both versions available in lengths from 1m to 3m. Profiles cannot be cut.
 Covers included with the power feed profiles.
 3m feed cable included in all linear feed products. Suspension accessories (steel cable or rod) to be ordered separately.
 90° corners in the same plane (symmetrical element for right and left corners) for the Up&Down and Down versions. Not provided for connection to the driver.

Elementos Lineales / Straight Elements

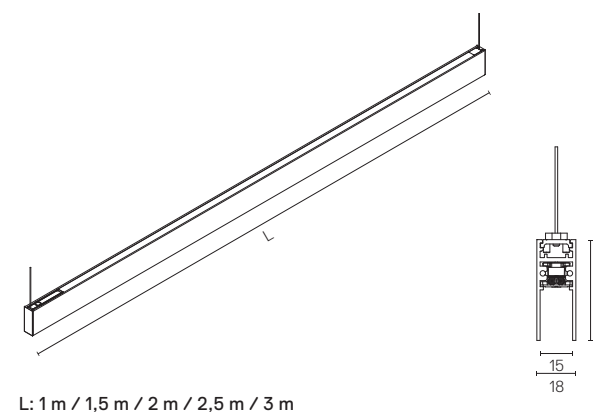

Esquina 90° / 90° Corner

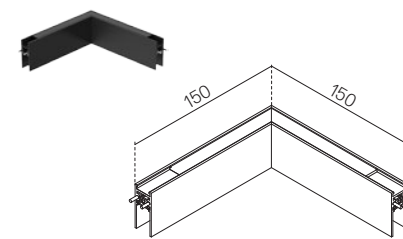

Ver accesorios disponibles.
 See available accessories.

Perfiles de Alimentación
 Feed Unit Profiles

- 1000 mm
- 06.1526.40A
- 06.1526.05A
- 06.1526.14A

- 1500 mm
- 06.1527.40A
- 06.1527.05A
- 06.1527.14A

- 2000 mm
- 06.1528.40A
- 06.1528.05A
- 06.1528.14A

- 2500 mm
- 06.1529.40A
- 06.1529.05A
- 06.1529.14A

- 3000 mm
- 06.1530.40A
- 06.1530.14A

Perfiles Intermedios
 Intermediate Profiles

- 1000 mm
- 06.1531.40A
- 06.1531.05A
- 06.1531.14A

- 1500 mm
- 06.1532.40A
- 06.1532.05A
- 06.1532.14A

- 2000 mm
- 06.1533.40A
- 06.1533.05A
- 06.1533.14A

- 2500 mm
- 06.1534.40A
- 06.1534.05A
- 06.1534.14A

- 3000 mm
- 06.1535.40A
- 06.1535.14A

- 90° Corner
- 06.1524.40A
- 06.1524.05A
- 06.1524.14A

THE TRACKING MAGNET SUSPENSION — ACCESSORIES

Accesorios Accessories

Rosetón de alimentación de superficie. Equipo no incluido, pedir por separado.

Surface rose. Driver not included. To be ordered separately.



08.8883.40A
08.8883.14A

Caja de alimentación de superficie tanto para luz directa como luz directa e indirecta con alojamiento para driver. Equipo 24V/185W incluido.

Surface power supply for direct and indirect lighting with housing for the driver. 24V/185W driver included.

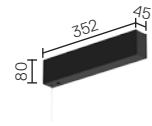

08.8886.40
08.8886.14

Rosetón de alimentación empotrado. Equipo no incluido, pedir por separado.

Recessed power supply rose. Driver not included. To be ordered separately.



08.8889.40
08.8889.14

Varillas rígidas para evitar la inclinación del perfil (estructuras rectilíneas sin esquinas) o para instalaciones donde se requiere sistema de fijación más rígido.

Rigid rod to avoid the profile from tilting (rectilinear structures without corners) or to be installed in places where a more rigid fixing system is required.

Varilla de suspensión de 1 m con rosetón con fileteado m6.

Suspension rod with 1m rose. m6 thread.



60.3014.11
60.3014.14

Alargo para varilla de suspensión de 1 m con fileteado m6.

1m suspension rod extension set m6 thread.



60.3097.11
60.3097.14

Cable de acero recomendado si una esquina está incluida en la estructura, donde la inclinación no aparecerá en ningún caso.

Steel cable, recommended if a corner is included in the light structure, where tilting will not occur in any case.

Cable de acero de suspensión de 4 m.

4m suspension steel cable.



08.8634.00

Cantidad de elementos de fijación necesarios (cables o varillas):

Cuando se realice la unión de perfiles rectilíneos, la cantidad necesaria resultará de la suma de los elementos necesarios por cada perfil, según tabla, menos uno por cada unión.

Amount of fastening elements necessary (cables or rods): for the union of rectilinear profiles, the necessary amounts shall be the sum of the necessary elements for each profile, according to the table, at least one for each joint.

Profile (mm)	Quantities Suspension Kit (units)	
	Feed Profile	Intermediate Profile
1000/1500	2	1
2000/2500	3	2
3000	4	3

THE TRACKING MAGNET — DRIVERS

Equipos Drivers

Fuente de alimentación LED para instalación remota en cuadro eléctrico 24V/185W.

Para evitar problemas de sobrecarga se recomienda instalar una fuente de alimentación cada 185W.



60.0004

LED power supply source for remote installation in 24V/185W electric control panel. To avoid problems of overload it is recommended to install a power source every 185W.

Transformador electrónico de tensión constante (24V) para LED. 100/240V.

Electronic transformer with constant voltage (24V) for LED. 100/240V.



60W
60.8496

THE TRACKING MAGNET — INSTALLATION PROFILES

SUSPENSION INSTALLATION

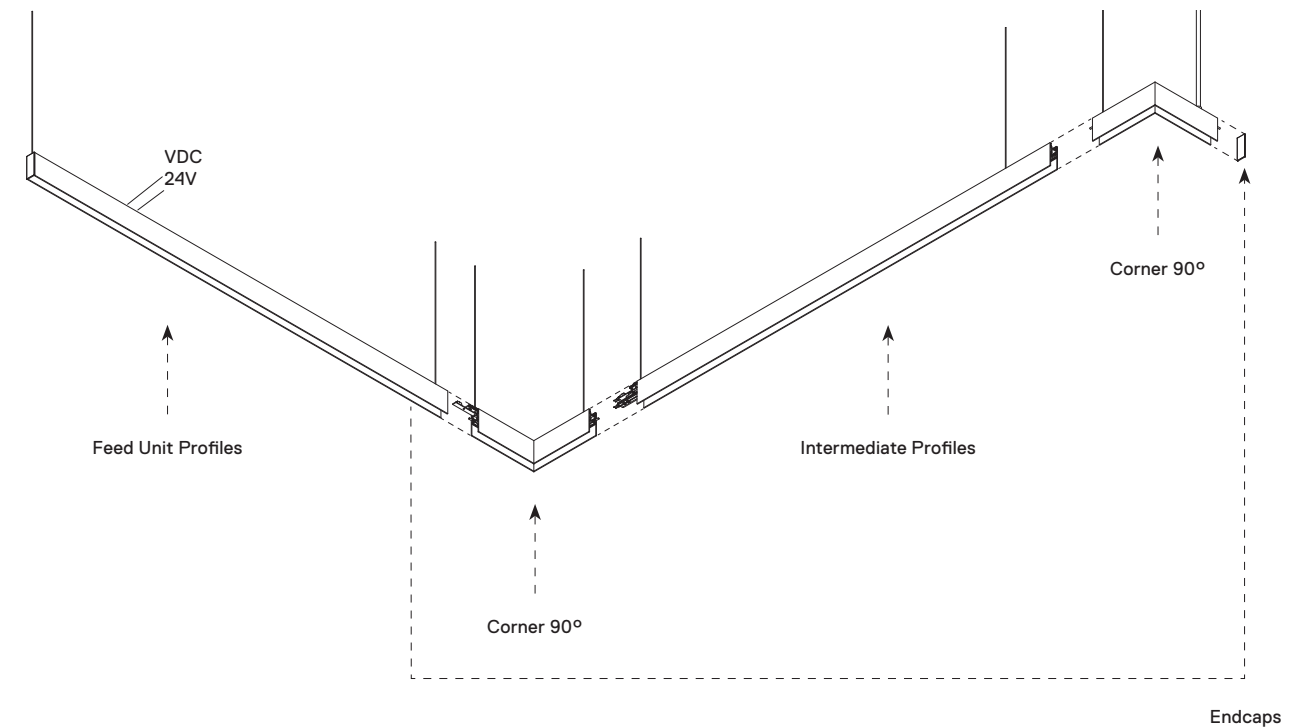

RECESSED INSTALLATION

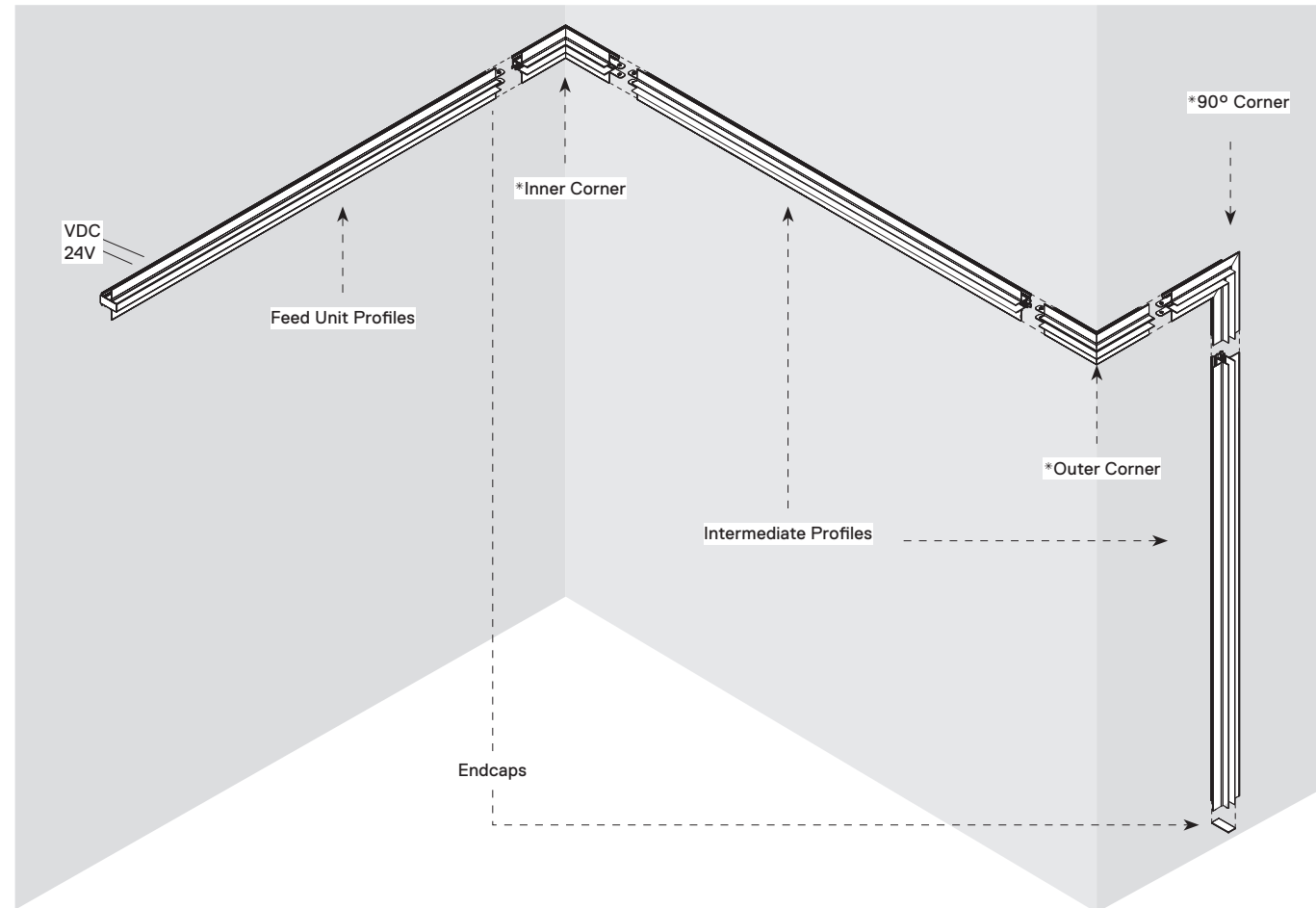

SURFACE INSTALLATION

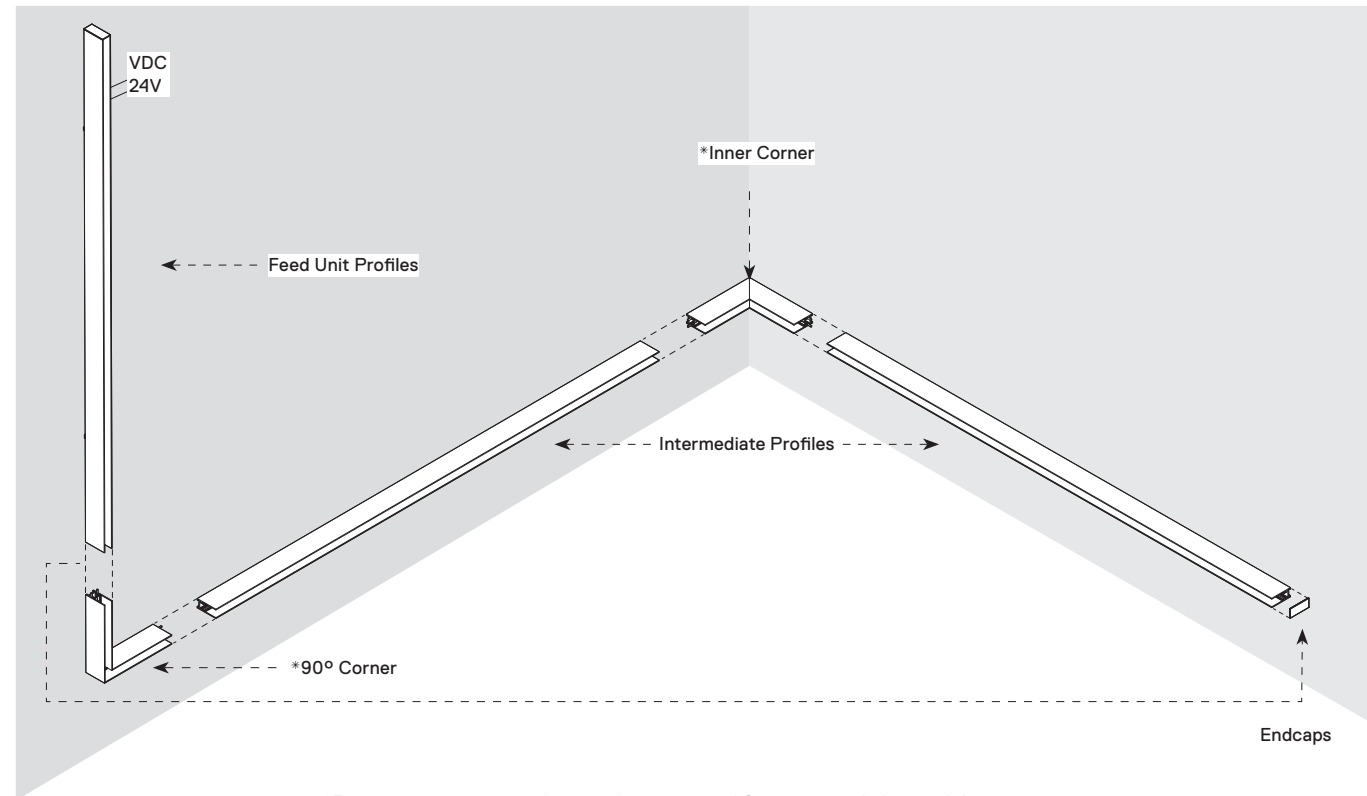

*Esquinas provistas para alimentar la estructura / Corners provided to feed the structure.

• ¿Puedo alimentar una estructura directamente desde una esquina sin utilizar un perfil de alimentación?

Sí, las esquinas están preparadas para alimentar una estructura en ambas direcciones sin la necesidad de utilizar un perfil de alimentación. Simplemente se ha de tener en cuenta que se deberán pedir por separado las tapas de los perfiles ya que no están incluidas en las esquinas y perfiles intermedios. Las esquinas en la versión Suspension no se pueden alimentar.

• ¿Puedo utilizar un perfil de alimentación para alimentar una estructura de superficie desde el centro?

Sí, para alimentar una estructura de superficie desde el centro (en ambas direcciones), se necesitarán dos perfiles de alimentación con dos fuentes de alimentación, una para cada perfil de alimentación, o la misma fuente de alimentación para ambos perfiles de alimentación, respetando las limitaciones eléctricas. La conexión mecánica entre los dos perfiles se puede realizar sin ningún problema.

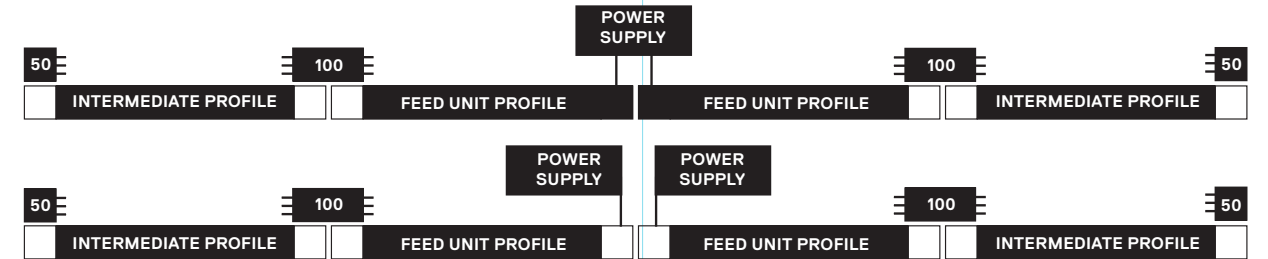

• ¿Puedo cortar un perfil?

Sí, los perfiles se pueden cortar a la medida deseada (excepto en las versiones suspendidas). Una vez se corta un perfil, se pierde la continuidad eléctrica. Si el perfil cortado no es el que cierra la estructura (en ese caso no se necesita continuidad eléctrica) el siguiente tramo se deberá volver a alimentar con una esquina o un perfil de alimentación.

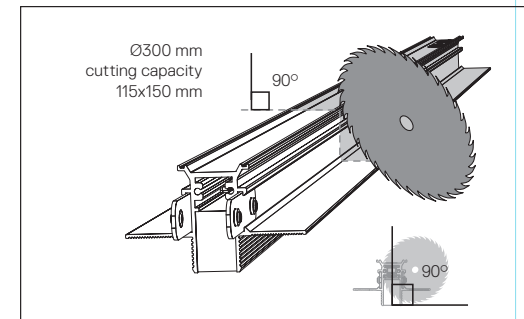

• Can I cut a profile?

Yes, profiles can be cut to the desired length (except suspended versions). Once a profile is cut, the electrical continuity is lost. If the cut element is not the one that closes the structure (in that case you don't need electrical continuity) the next section must be fed with a corner or a Feed Unit Profile.

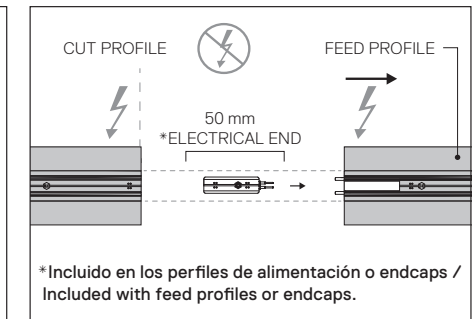

• ¿En la versión Up&Down, la iluminación Up comparte encendido con la iluminación Down?

Sí, debido a las dimensiones reducidas del perfil Tracking Magnet, el conector de 24V de cada perfil de alimentación es único, y es por ello por lo que la luz indirecta debe estar conectada en el mismo circuito que la luz directa.

• ¿Cuál es la distancia máxima permitida entre la fuente de alimentación y el perfil?

Con la fuente de alimentación de 185W (60.0004) de nuestro catálogo, la distancia máxima permitida es:
 . Cable de Ø 1,5mm: 3 metros
 . Cable de Ø 2,5mm: 5 metros

• ¿Cuál es la longitud máxima que se puede alimentar con una fuente de alimentación en una estructura?

La longitud máxima de un perfil que puede alimentarse con una fuente de alimentación es 8m.

• ¿Puedo utilizar una fuente de alimentación diferente - menos potente?

Toda la información publicada en nuestra web, catálogo e instrucciones de instalación se ajusta a los tests realizados con nuestra fuente de alimentación de 185W (60.0004) recomendada para nuestros productos. De todas formas, se puede utilizar una fuente de alimentación diferente para alimentar los perfiles, pero teniendo en cuenta las limitaciones eléctricas que debe cumplir. Debe ser una fuente de alimentación de 24V con una corriente eléctrica máxima de 8A.

• In the Up&Down version, is the Up light on the same circuit as the Down light?

Yes, the Tracking Magnet has a small profile so the 24V connector for each profile is unique, and therefore the up light has to be on the same circuit as the down light.

• What is the maximum distance allowed between the driver and the profile?

With the 185W power supply (60.0004) in our catalogue, the maximum distance allowed is:
 . Ø 1.5mm cable: 3 meters
 . Ø 2.5mm cable: 5 meters

• What is the maximum length that can be fed with one Power Supply?

The maximum profile length that can be fed with a power supply is 8m.

• Can I use a different, less powerful Power Supply?

All the information published on our website, and in our catalogue and installation instructions sheets is adjusted to the tests we perform with our 185W power supply (60.0004), which we recommend for our products. However, a different power supply can be used to feed the profiles but the electrical limitations that it will have to accomplish should be taken into account. It should be a 24V power supply with a maximum electric current of 8A.

THE TRACKING MAGNET — LIGHT MODULES

LIGHT STRIPE

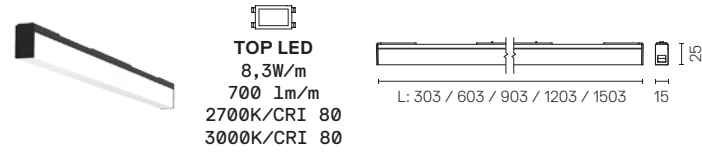

TOP LED
8,3W/m
700 lm/m
2700K/CRI 80
3000K/CRI 80

Módulo de iluminación LED de luz difusa para ser instalado en el sistema The Tracking Magnet. No Dimmable.

Diffused LED light module to be installed in The Tracking Magnet System. Non Dimmable.

L (mm)	Power (W)	Luminous flux of luminaire up to (lm) 2700K/3000K
300	2,7	230
600	5,4	460
900	8,1	685
1200	10,8	915
1500	13,5	1145

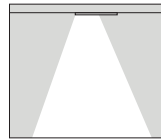

LED INCL.
NOT REPLACEABLE

300 mm
2700K
03.6370.14
3000K
03.6360.14

600 mm
2700K
03.6371.14
3000K
03.6361.14

900 mm
2700K
03.6372.14
3000K
03.6362.14

1200 mm
2700K
03.6373.14
3000K
03.6363.14

1500 mm
2700K
03.6374.14
3000K
03.6364.14

THE TRACKING MAGNET — LIGHT MODULES

ANTHONY SPOT CEILING

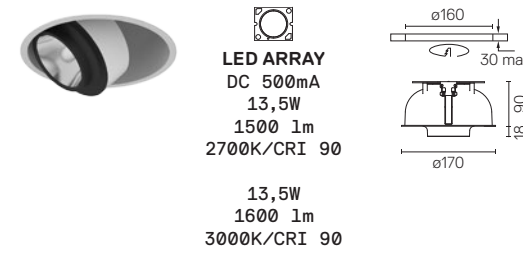

LED ARRAY
DC 500mA
13,5W
1500 lm
2700K/CRI 90

13,5W
1600 lm
3000K/CRI 90

Empotrable de altas prestaciones para fuente de luz LED. Fuente de alimentación remota 220-240V no incluida.

High-performance embedded light fixture for LED light source. Remote 220-240V power supply not included.

2700K
03.6415.40A
03.6415.05A
03.6415.14A
3000K
03.6416.40A
03.6416.05A
03.6416.14A



Cuerpo empotrado acabado en blanco para todos los decorados; acabado en negro disponible bajo pedido.

Standard trim cove in white for all finishes; black finish available under request.

Equipos recomendados:
Recommended power supply:

Non Dimmable 60.8673
Dimmable Dali 60.8485
110V Non Dimmable 60.9233
110V Dimmable Dali 60.8847

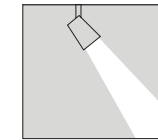

2700K
03.6417.40A
03.6417.05A
03.6417.14A
3000K
03.6418.40A
03.6418.05A
03.6418.14A



2700K
03.6419.40A
03.6419.05A
03.6419.14A
3000K
03.6420.40A
03.6420.05A
03.6420.14A



LED INCL.
NOT REPLACEABLE

Accesorios
Accessories

Lente elíptica.
Elliptical lens.

08.8418.68A

Anthony Spot

Honeycomb.
Honeycomb.

08.8419.14A

ANTHONY SPOT TRACK

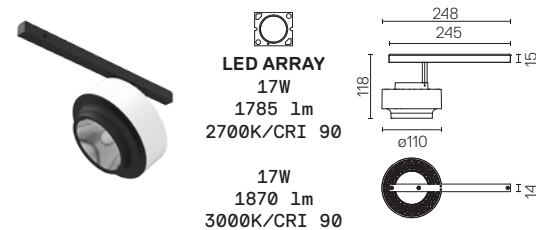

LED ARRAY
17W
1785 lm
2700K/CRI 90

17W
1870 lm
3000K/CRI 90

Módulo de iluminación LED de acento para ser instalado en el sistema The Tracking Magnet. Convertidor electrónico de corriente DC/DC incorporado.

Accent lighting LED module to be installed in The Tracking Magnet System. Built-in DC/DC electronic voltage converter.

2700K
03.6401.40A
03.6401.05A
03.6401.14A
3000K
03.6400.40A
03.6400.05A
03.6400.14A



2700K
03.6403.40A
03.6403.05A
03.6403.14A
3000K
03.6402.40A
03.6402.05A
03.6402.14A



2700K
03.6405.40A
03.6405.05A
03.6405.14A
3000K
03.6404.40A
03.6404.05A
03.6404.14A



Máximo 8 spots para un mismo driver. Para otras combinaciones consultar con FLOS.

Maximum 8 spots for a single driver. Ask FLOS for other combinations.

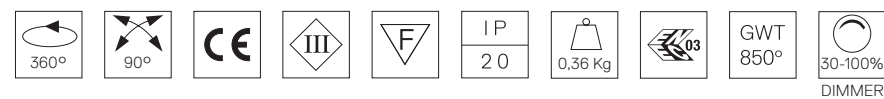
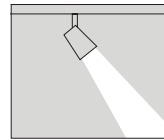

LED INCL.
NOT REPLACEABLE

THE TRACKING MAGNET — LIGHT MODULES

SPOT TRACKING 50



POWER LED
4,2W
410 lm
2700K/CRI 90

4,2W
440 lm
3000K/CRI 90

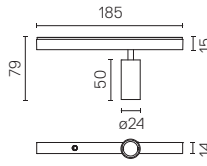

Módulo de iluminación LED de acento para ser instalado en el sistema The Tracking Magnet. Convertidor electrónico de corriente DC/DC incorporado.

Accent lighting LED module to be installed in The Tracking Magnet System. Built-in DC/DC electronic voltage converter.

2700K
03.6441.40
03.6441.05
03.6441.14

3000K
03.6440.40
03.6440.05
03.6440.14

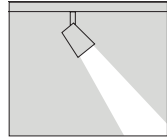

360° 90° CE III F IP 20 0,05 Kg PENDING GWT 850° 30-100% DIMMER LED INCL. NOT REPLACEABLE

SPOT TRACKING 90



POWER LED
9,6W
850 lm
2700K/CRI 90

9,6W
900 lm
3000K/CRI 90

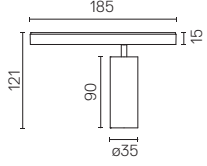

Módulo de iluminación LED de acento para ser instalado en el sistema The Tracking Magnet. Convertidor electrónico de corriente DC/DC incorporado.

Accent lighting LED module to be installed in The Tracking Magnet System. Built-in DC/DC electronic voltage converter.

2700K
03.6411.40
03.6411.05
03.6411.14

3000K
03.6410.40A
03.6410.05A
03.6410.14A

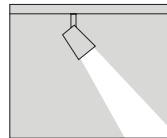
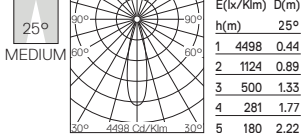

Máximo 13 spots para un mismo driver. Para otras combinaciones consultar con FLOS.

Maximum 13 spots for a single driver. Ask FLOS for other combinations.

360° 90° CE III F IP 20 0,18 Kg PENDING GWT 850° 30-100% DIMMER LED INCL. NOT REPLACEABLE

THE TRACKING MAGNET — LIGHT MODULES

SPOT TRACKING 120



POWER LED
12,5W
985 lm
2700K/CRI 90

12,5W
1060 lm
3000K/CRI 90

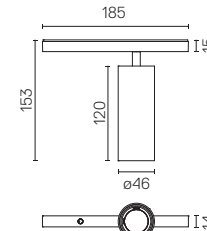

Módulo de iluminación LED de acento para ser instalado en el sistema The Tracking Magnet. Convertidor electrónico de corriente DC/DC incorporado.

Accent lighting LED module to be installed in The Tracking Magnet System. Built-in DC/DC electronic voltage converter.

2700K
03.6413.40
03.6413.05
03.6413.14

3000K
03.6412.40A
03.6412.05A
03.6412.14A

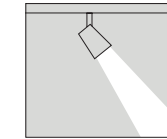
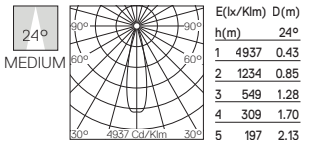

Máximo 10 spots para un mismo driver. Para otras combinaciones consultar con FLOS.

Maximum 10 spots for a single driver. Ask FLOS for other combinations.

360° 90° CE III F IP 20 0,30 Kg PENDING GWT 850° 30-100% DIMMER LED INCL. NOT REPLACEABLE

EASY SPOT TRACKING



LED QR-CBC 51
GX5.3
MAX 8W

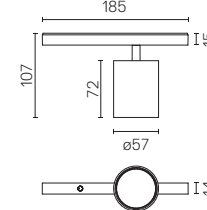

Módulo de iluminación LED de acento para ser instalado en el sistema The Tracking Magnet. Convertidor electrónico de corriente DC/DC incorporado.

Accent lighting LED module to be installed in The Tracking Magnet System. Built-in DC/DC electronic voltage converter.

Non Dimmable
03.6414.40
03.6414.05
03.6414.14

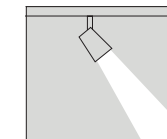

Máximo 17 spots no dimables para un mismo driver. Para otras combinaciones consultar con FLOS.

Maximum of 17 non-dimmable spots for a single driver. Ask FLOS for other combinations.

360° 90° CE III F IP 20 0,18 Kg PENDING GWT 850° A



Sistema de fijación magnética que permite la instalación de los módulos de luz sin cables.

Magnetic fixture system that permits installing light modules without cable.

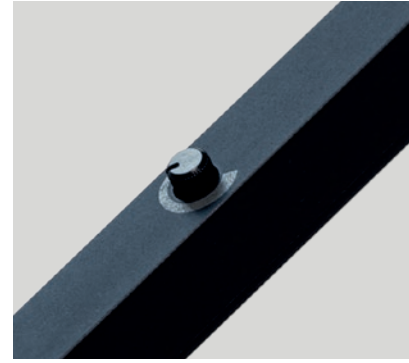

Sistema de regulación lumínico integrado en el cuerpo de la luminara.

Regulation system for light dim integrated into the body of the luminaire.



Anthony Spot diseñado por Antonio Citterio disponible para instalación en sistema Tracking Magnet.

Anthony Spot designed by Antonio Citterio and available to be installed on the Tracking Magnet system.

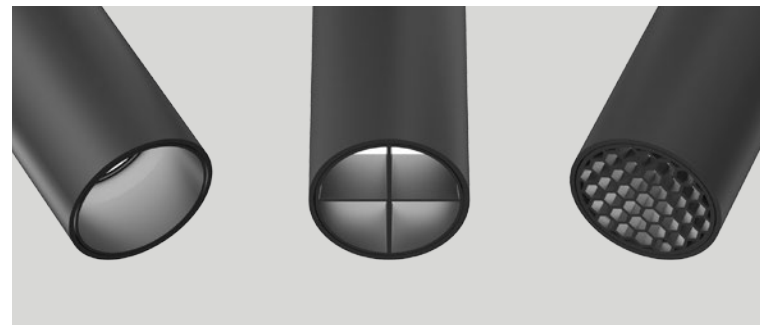

Cilindro de apantallamiento con cruceta y honeycomb incluidos en los Spots Tracking Magnet 90 y 120.

Cylindrical reflector with anti-glare cross-head and honeycomb included with 90 and 120 Spots Tracking Magnet.

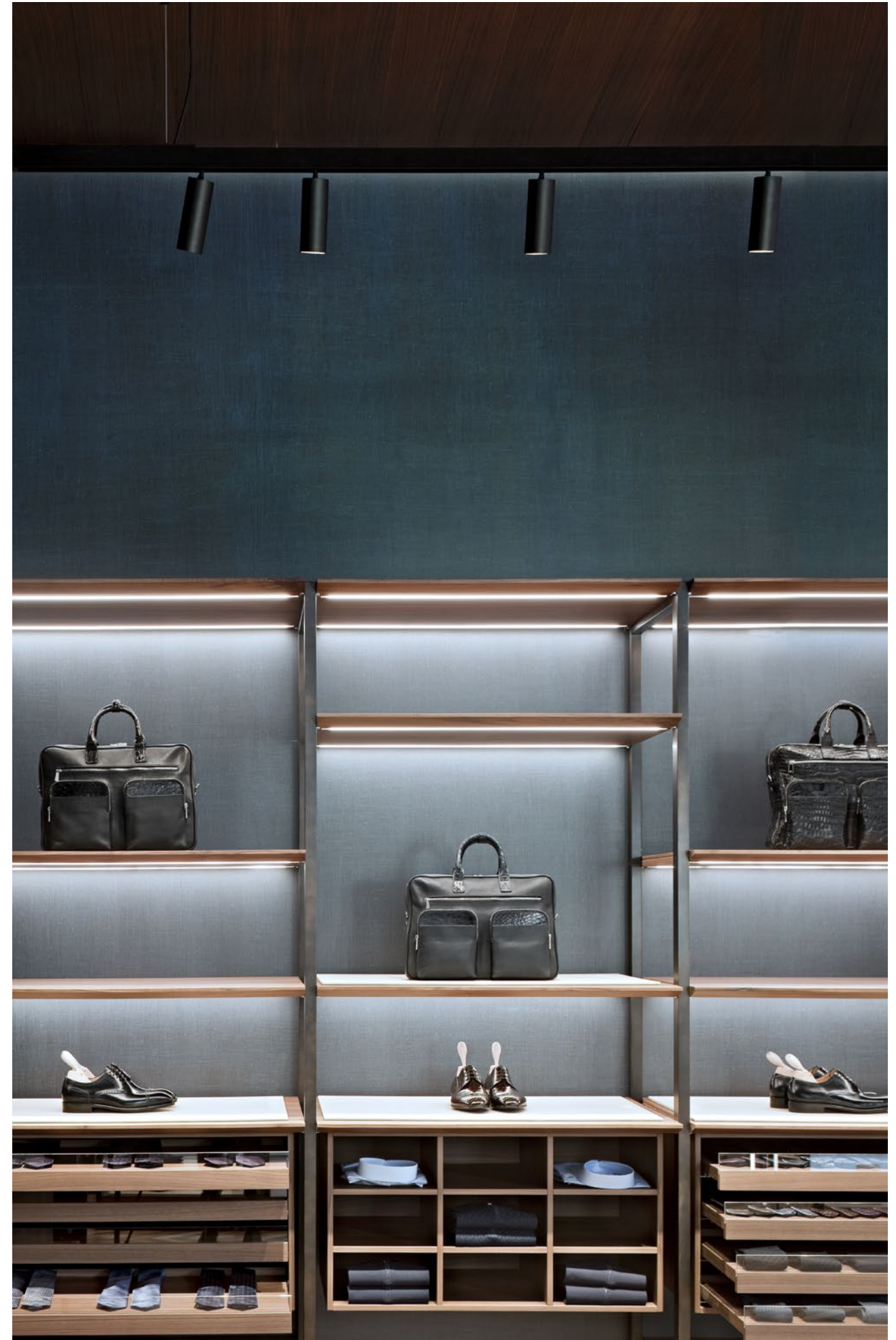

Dimensión mínima en un carril trifásico empotrado de gran potencia. Mínimo impacto visual de las luminarias de alta potencia, gracias a la miniaturización de los componentes electrónicos. Luminarias de alta eficiencia e instalación universal.

THE TRACKING POWER

Minimum measurements in a high-powered three-phase embedded track. The high-powered luminaires has minimum visual impact thanks to the miniaturisation of the electronic components. Highly efficient luminaires and universal installation.







Descripción

Exclusivo sistema trifásico de iluminación para interiores en versión empotrada, que gracias a su bajo impacto visual, ofrece una total integración en la arquitectura.

Los perfiles estructurales del Tracking Power han sido realizados con aluminio extruido en negro, provistos de pistas eléctricas sobre las cuales se instalan las luminarias mediante el sistema exclusivo de fijación Flos.

La familia Tracking Power se completa con los proyectores UT Pro 150, que combinados con una electrónica exclusiva integrada en el cuerpo de la luminaria permite un impacto visual mínimo.

Una vez instalado el carril, solo se observa una pequeña línea de 15mm de grosor.

Disponibles soluciones para carriles trifásicos estándar.

Sistema Óptico

El módulo de luz UT Pro 150 se encuentra disponible con ópticas Spot, Medium y Flood, con reflector de cristal borosilicato de alta eficiencia incorporado.

Unidades de Alimentación

Fuente de alimentación 220-240V, 50-60Hz integrada en el cuerpo de la luminaria.

Accesorios

- UT Pro 150:

Disponibles cruceta de apantallamiento, lente elíptica, lente Flood y Honeycomb.

Información Adicional

- UT Pro 150:

Posibilidad de rotación 360° en eje vertical y 90° en eje horizontal.

Índice de protección IP20.

Adaptador de reducidas dimensiones que una vez instalado se integra en su totalidad dentro del perfil, especialmente diseñado para utilización en perfil FLOS The Tracking Power. También compatible con carriles fabricados por Eutrac, Erco y Zumtobel.

Disponible bajo pedido versión con adaptador estándar Nordic GA69 para instalación en carriles trifásicos estándar de FLOS. Compatibilidad garantizada con carriles trifásicos fabricados por Nordic, Eutrac, Erco, Zumtobel e iGuzzini.

- Perfil:

Únicamente instalable en techos de cartón-yeso de 12,5mm de espesor.

Instalable sobre superficies normalmente inflamables.

Cumplimiento de Normativa y Marcas de Calidad

Luminaria conforme con la Normativa Técnica Europea EN60598-1 y partes segundas.

Description

An exclusive three-phase lighting system for interiors in its embedded version. Thanks to its low visual impact, it fully integrates into the architecture.

The structural profiles of the Tracking Power have been created with black extruded aluminium and fitted with electric tracks where the luminaires are installed using the exclusive Flos fastening system.

The Tracking Power family is completed with the UT Pro 150 projectors, which, combined with an exclusive electronics integrated within the body of the luminaire, allows for minimum visual impact.

Once the track is installed, we can only see a small 15 mm line.

There are solutions for standard three-phase tracks.

Optic system

The UT Pro 150 light module is available for Spot, Medium and Flood optics, with a high-efficient borosilicate glass reflector included.

Power Supply

A 220-240V power supply, 50-60Hz integrated into the body of the luminaire.

Accessories

- UT Pro 150:

Screening crosspiece, elliptical lens, Flood lens and Honeycomb.

Additional Information

- UT Pro 150:

It has the possibility of 360° rotation on the vertical axle and 90° on the horizontal axle.

IP20 protection grade.

Small-sized adaptor, which, once installed, is fully integrated into the profile. Especially designed to be used with the FLOS Tracking Power profile. Also compatible with tracks manufactured by Eutrac, Erco and Zumtobel.

The version with a standard Nordic GA69 version for installation in standard FLOS three-phase tracks is available on request. Compatibility ensured with three-phase tracks manufactured by Nordic, Eutrac, Erco, Zumtobel and iGuzzini.

- Profile:

Can only be installed in 12.5mm thick plaster-board.

Suitable for installation on normally inflammable surfaces.

Compliance of Standards and Quality Marks

EN60598-1 European Technical Standards and any subsequent additions.

LIGHT MODULES

UT PRO
150



LED ARRAY

- 19W
- 2150 1m
- 3000K/CRI 80
- 19W
- 1750 1m
- 3000K/CRI 90
- 19W
- 1750 1m
- 4000K/CRI 90

Colores
Colours



- 14 Negro
- 14 Black

THE TRACKING POWER RECESSED — PROFILES

Perfiles / Profiles

Carril trifásico con mínimo impacto en la arquitectura (15mm), para instalaciones empotradas en techos de cartón yeso.
 Carriles lineales disponibles en tres longitudes: 1m, 2m, 3m y 4m.
 Disponibles esquinas de 90° en el mismo plano (diferentes elementos para esquina izquierda y derecha).
 Necesario conector intermedio lineal para conectar varios perfiles.
 Conectores de alimentación disponibles para instalación en lado izquierdo o derecho.
 Tapas incluidas en los conectores de alimentación.
 La fijación del Tracking Power se realiza atornillando las alas del perfil a la superficie de cartón yeso ayudándose de perfiles de aluminio de sujeción.
 El Kit de sujeción a techo ajustable (opcional) permite la instalación sin necesidad de perfiles de aluminio de sujeción.
 Recomendado para instalaciones en las que se puede instalar el perfil Tracking Power antes que el falso techo de cartón yeso.

Three-phase track with minimum impact on the architecture (15mm) for embedded installations in plasterboard ceilings.
 Linear tracks available in three lengths: 1m, 2m, 3m and 4m.
 90° corners on the same plane are also available (different elements for the left and right corners).
 A linear intermediate connector is required to connect several profiles.
 Power supply connectors available for the installation on the left or right-hand side.
 Endcaps included in the power supply connectors.
 The fastening of the Tracking Power is performed by screwing the sides of the profile to the plasterboard surface, aided by aluminium fastening profiles.
 The adjustable ceiling fastening Kit (optional) permits the installation without the need for fastening aluminium profiles.
 Recommended for installations where the Tracking Power profile can be installed before the suspended plasterboard.

Elementos Lineales / Straight Elements

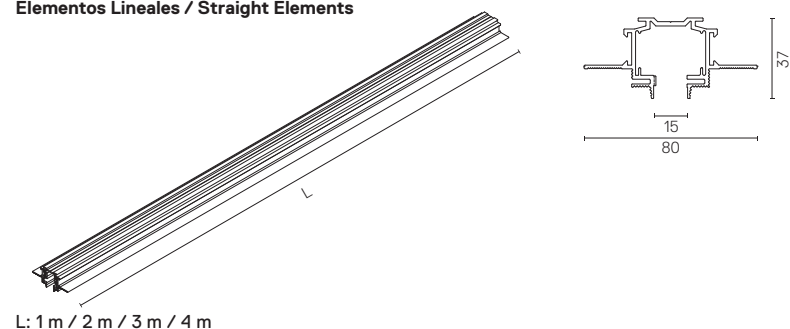

Esquina 90° / 90° Corner

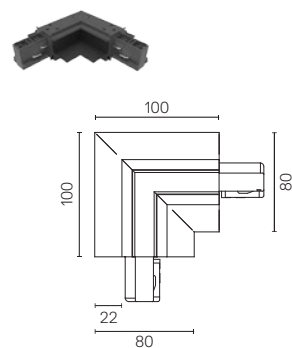

Conector Alimentación / Feed Connector

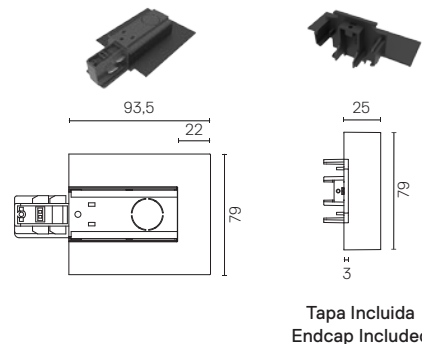

Kit de Sujeción a Techo Ajustable / Adjustable Ceiling Kit (optional)

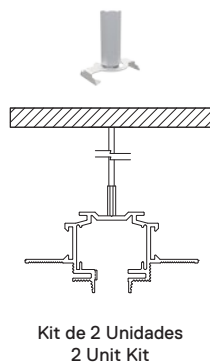

Profile (mm)	Quantities Ceiling Kit (units)
1000	2
2000	4
3000	6
4000	8

Profiles

- 1000 mm ■ 06.1800.14
- 2000 mm ■ 06.1801.14
- 3000 mm ■ 06.1802.14
- 4000 mm ■ 06.1803.14

90° Corner

- Right ■ 06.1804.14
- Left ■ 06.1805.14

Feed Connector

- Right ■ 06.1807.14
- Left ■ 06.1806.14

Intermediate Linear Connector

- 60.3319.14

Adjustable Ceiling Kit

- 2 Unit Kit ■ 08.8439.14

THE TRACKING POWER — INSTALLATION PROFILE

Para garantizar la seguridad eléctrica en la instalación, el perfil de Tracking Power es asimétrico y ofrece una forma única para la instalación de las luminarias.
 En el diagrama se muestra la posición del carril neutro (línea roja) para las distintas configuraciones posibles, que ha de componerse de acuerdo a los requisitos de cada instalación, respetando la continuidad eléctrica.

The Tracking Power profile is asymmetric to ensure the electric safety in the installation, and it provides a unique form in the installation of luminaires.
 The diagram shows the position of the neutral track (red line) for the different possible configurations, which must be composed according to the requirements for each installation, respecting the electric continuity.

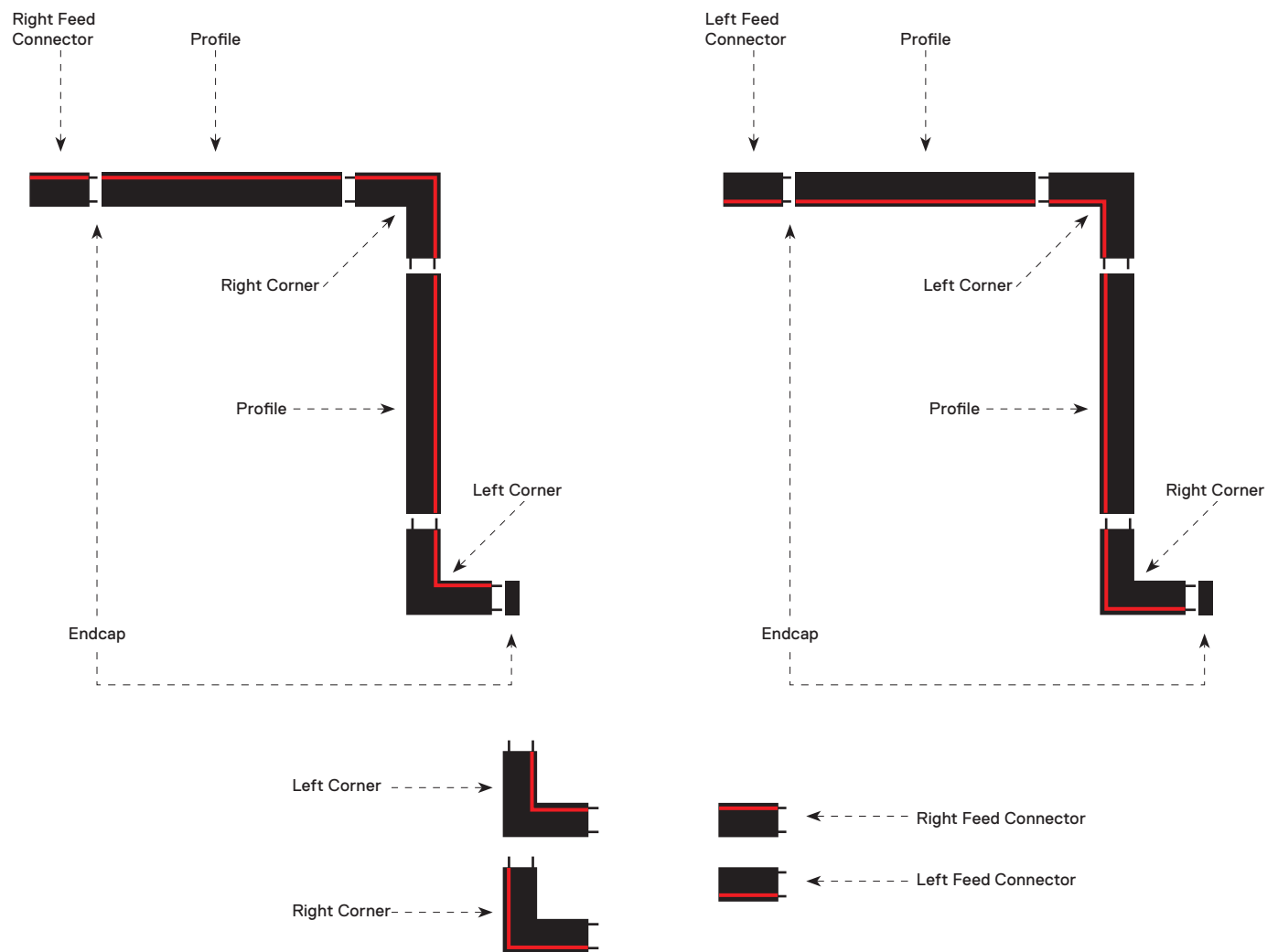

THE TRACKING POWER — LIGHT MODULES



LED ARRAY
19W
2150 lm
3000K/CRI 80

19W
1750 lm
3000K/CRI 90

19W
1750 lm
4000K/CRI 90

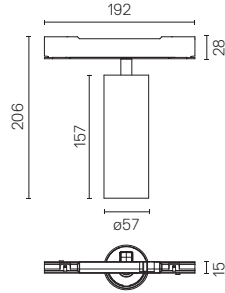

Proyector para ser instalado a carril trifásico con fuente de luz LED. Fuente de alimentación 220-240V, 50-60Hz integrada.

Spotlight to be installed on 3-phase track with LED light source. 220-240V, 50-60Hz power supply integrated.

3000K - CRI 80
09.7210.40
09.7210.14

3000K - CRI 90
09.7216.40
09.7216.14

4000K - CRI 90
09.7211.40
09.7211.14

3000K - CRI 80
09.7212.40
09.7212.14

3000K - CRI 90
09.7217.40
09.7217.14

4000K - CRI 90
09.7213.40
09.7213.14

3000K - CRI 80
09.7214.40
09.7214.14

3000K - CRI 90
09.7218.40
09.7218.14

4000K - CRI 90
09.7215.40
09.7215.14



SPOT



MEDIUM



FLOOD

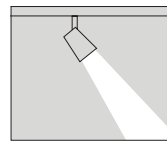

360° 90° CE F IP 20 0.52 Kg PENDING GWT 850° 10-100% DIMMER

LED INCL. NOT REPLACEABLE

UT PRO 150

ACCESORIOS / ACCESSORIES

Cruceta de apantallamiento, lentes y Honeycomb directamente instalables en la cabeza de la luminaria sin necesidad de accesorio de sujeción. Compatibilidad de instalación de Honeycomb + Lente al mismo tiempo.

Screening crosspiece, lenses and Honeycomb directly installable on the head of the luminaire without needing any fastening accessory. Installation compatible with Honeycomb + Lense at the same time.

Cruceta de apantallamiento. 08.8429.00

Screening crosspiece.



Lente elíptica. 08.8431.00

Elliptical lens.



Lente Flood. 08.8432.00

Flood lens.



Honeycomb. 08.8428.00

Honeycomb.





Adaptador trifásico exclusivo Flos para la máxima integración de la luminaria en el carril trifásico. Una vez instalado, el adaptador permanece oculto dentro del carril.

Exclusive Flos three-phase adaptor for maximum integration of the luminaire into the profile. Once installed, the adapter will be hidden in the three phase track.



Adaptador trifásico universal para instalación de las luminarias en carril trifásico estándar y en instalaciones existentes.

Universal three-phase adapter to install the luminaires in a standard three-phase track and existing installations.



Reflector especial de cristal borosilicato: eficiencia de hasta un 90% y perfecta distribución del haz de luz.

Special borosilicate glass reflector: efficiency of up to 90% and a perfect distribution of the light beam.



THE BLACK LINE

Sistema empotrado de dimensión reducida, con el máximo confort visual y apantallamiento total. Accesibilidad absoluta de las fuentes de luz para mantenimiento de las luminarias. Soluciones con óptica cerrada para iluminación de acento o abierta para iluminación general, permite también la composición en línea continua.

THE BLACK LINE

A small-sized embedded system with maximum visual comfort and total screening. Absolute accessibility to the sources of light to feed the luminaires. Closed optics solutions for accent illumination or open for general illumination, enabling a continuous line composition.

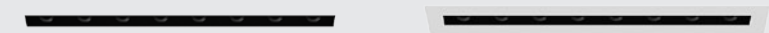

DESIGNED BY FLOS ARCHITECTURAL

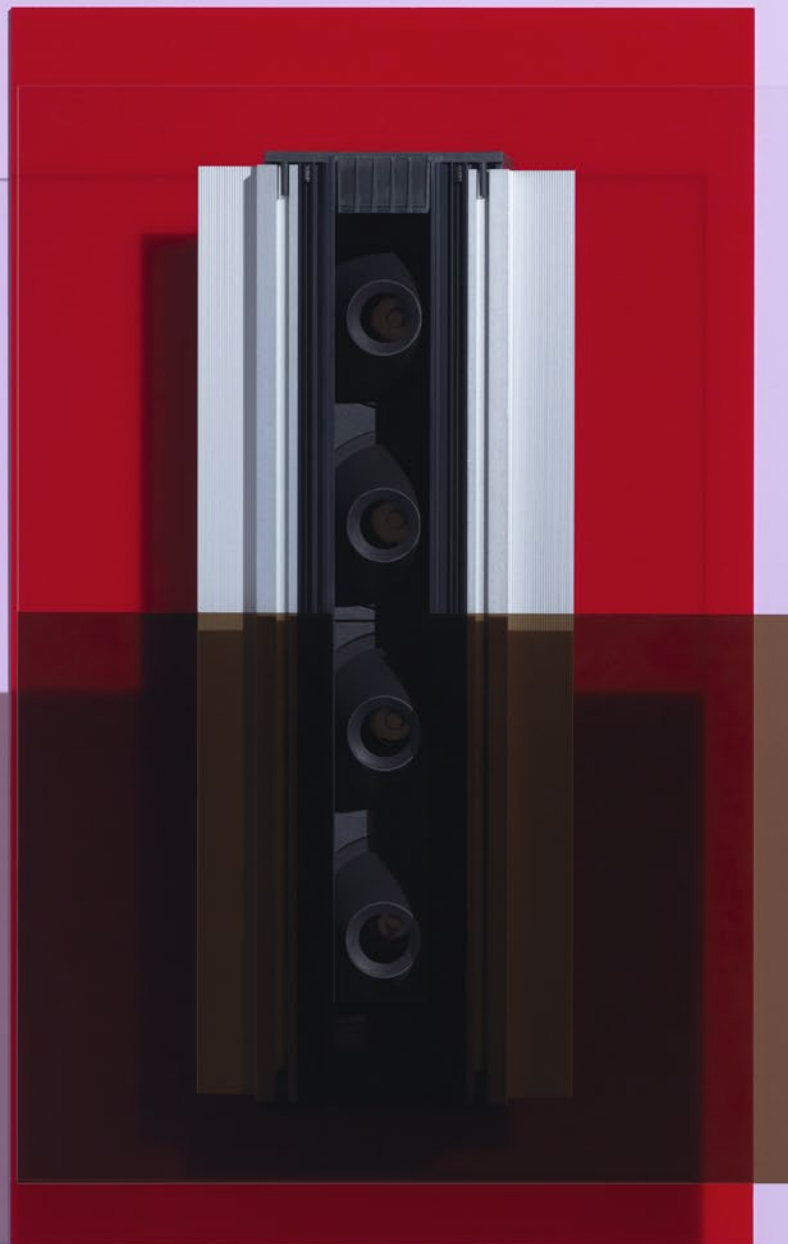
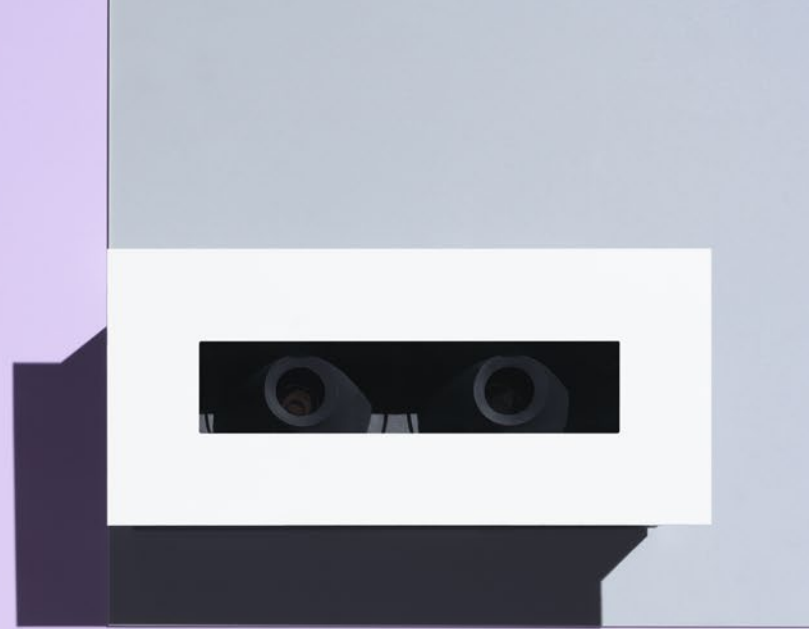







Descripción

Revolucionaria familia de luminarias LED para interiores: un nuevo concepto de iluminación, con una combinación única de empotrables para un efecto inmejorable de homogeneidad.

El corazón de estas luminarias consiste en una línea de conos de silicona especialmente diseñados, con fijación magnética sobre una extrusión de aluminio compacta que alberga los circuitos electrónicos, sirviéndose de unas dimensiones muy reducidas para simplificar la instalación y permitir el mantenimiento de la placa LED en las versiones No Trim.

Los conos cubren cada módulo LED del sistema, proporcionando una intensidad máxima limitada para mejorar el confort visual y, al mismo tiempo, moldear la forma de la luz, en haces estrechos o difuminados, conforme a los requisitos del proyecto.

La geometría especial de las lentes integradas en los conos delimitados contribuye a crear una iluminación virtualmente libre de reflejos, totalmente agradable. Asimismo, el sistema de soporte magnético de los conos permite un acceso total a la luminaria una vez instalada. La familia está disponible en configuraciones de 2/4/8/12 focos, con ópticas de iluminación general y de acento.

Todas las opciones están disponibles sin marco de empotramiento (No Trim), para una integración total dentro de la arquitectura y un resultado estético perfecto, así como con marco de empotramiento (Trim), para una instalación más sencilla.

El marco externo de la versión Trim está disponible en acabado blanco o en imprimación para su posterior pintado en función del color del techo.

La versión No Trim se puede interconectar para construir una línea continua.

Unidades de Alimentación

Fuente de alimentación remota de 1050 mA no incluida.

Información Adicional

La versión No Trim se ha diseñado para una instalación en placas de escayola de un espesor de 12,5 mm.

En la versión No Trim, instalar el driver en una posición accesible.

Índice de protección IP20.

Clase de aislamiento III.

Cumplimiento de Normativa y Marcas de Calidad

Luminaria conforme con la Normativa Técnica Europea EN60598-1 y partes segundas.

Description

Revolutionary LED family for indoor use, offering a new concept of illumination, with a unique combination of multiple spots for an unmatched effect of homogeneity. The core of the luminaires is a line of specially designed silicon cones, magnetically fixed on a compact aluminum extrusion hosting the electronics, with a very reduced size to simplify installation and allow LED maintenance in the No Trim version.

The cones cover each of the system's LED modules, providing maximum cut-off to enhance visual comfort and, at the same time, determine the shape of the light, in a narrow or flood beam, according to the requirements of the project.

The special geometry of the lens integrated in the cut-off cones contributes to a virtually glare-free, totally comfortable illumination, and the magnetic mounting system of the cones makes the lamp totally accessible once installed.

The family is available in lines of 2/4/8/12 spots, with accent lighting and general lighting optics.

All options are available in a No Trim version, for total integration into the architecture and a perfect aesthetic result, and a Trim version, for simpler installation.

The external frame of the trim version is available in a white or a primer finish, to be painted in the same color as the ceiling.

No Trim version can be connected in a continuous line.

Power Supply

1050 mA remote power supply not included.

Additional Information

The No Trim version is designed for installation in 12.5mm thick plaster-board.

For the No Trim version, install drive in an accessible position.

IP20 protection grade.

Insulation class III.

Standard Compliance and Quality Marks

EN60598-1 European Technical Standards and any subsequent additions.

NO TRIM
2 SPOTS



NO TRIM
4 SPOTS

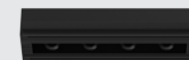

NO TRIM
8 SPOTS

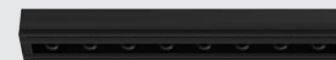

NO TRIM
12 SPOTS



TRIM
2 SPOTS



TRIM
4 SPOTS



TRIM
8 SPOTS



TRIM
12 SPOTS



POWER LED
6,5W
2x197 lm
2700K/CRI 90
6,5W
2x200 lm
3000K/CRI 90

POWER LED
13W
4x197 lm
2700K/CRI 90
13W
4x200 lm
3000K/CRI 90

POWER LED
26W
8x197 lm
2700K/CRI 90
26W
8x200 lm
3000K/CRI 90

POWER LED
39W
12x197 lm
2700K/CRI 90
39W
12x200 lm
3000K/CRI 90

**Colores
Colours**

The Black Line No Trim

■ 14 Negro
■ 14 Black



The Black Line Trim

□ 00 Imprimación
□ 00 Primer

□ 40 Blanco
□ 40 White

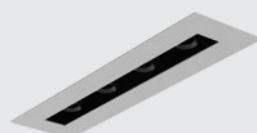

THE BLACK LINE

[THE BLACK LINE NO TRIM] 2 SPOTS

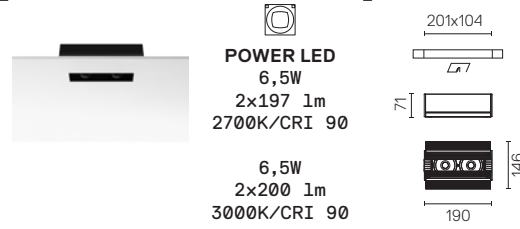

POWER LED
6,5W
2x197 1m
2700K/CRI 90

6,5W
2x200 1m
3000K/CRI 90

Luminaria empotrable de 2 focos LED. Fuente de alimentación remota de 1050 mA no incluida.

Recessed integrated luminaire with 2 LED lighting spots. 1050 mA remote power supply not included.

2700K
■ 03.0051.14ANT
3000K
■ 03.0050.14ANT

2700K
■ 03.0053.14ANT
3000K
■ 03.0052.14ANT

Equipos recomendados:
Recommended power supply:

Non Dimmable 60.8670
Dim 1-10V / Dim Dali / Push 60.8530

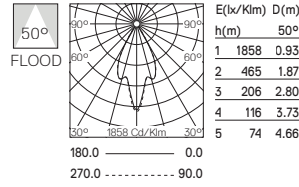
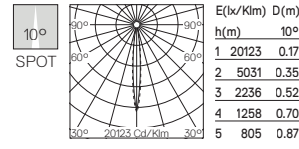

THE BLACK LINE

[THE BLACK LINE NO TRIM] 8 SPOTS

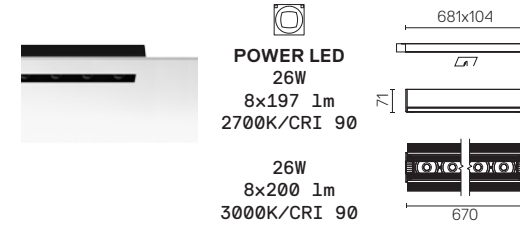

POWER LED
26W
8x197 1m
2700K/CRI 90

26W
8x200 1m
3000K/CRI 90

Luminaria empotrable de 8 focos LED. Fuente de alimentación remota de 1050 mA no incluida.

Recessed integrated luminaire with 8 LED lighting spots. 1050 mA remote power supply not included.

2700K
■ 03.0059.14ANT
3000K
■ 03.0058.14ANT

2700K
■ 03.0061.14ANT
3000K
■ 03.0060.14ANT

Equipos recomendados:
Recommended power supply:

Non Dimmable 60.8548
Dimmable Dali 60.8549
Dim 1-10V / Dim Dali / Push 60.8530

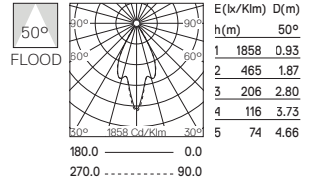
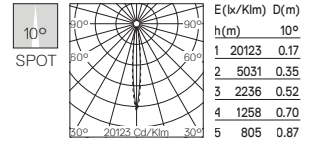

[THE BLACK LINE NO TRIM] 4 SPOTS

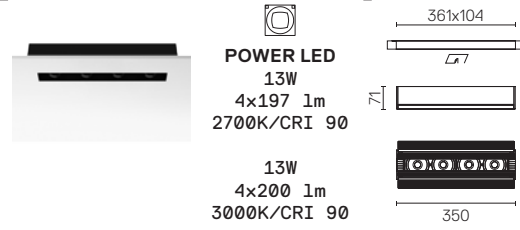

POWER LED
13W
4x197 1m
2700K/CRI 90

13W
4x200 1m
3000K/CRI 90

Luminaria empotrable de 4 focos LED. Fuente de alimentación remota de 1050 mA no incluida.

Recessed integrated luminaire with 4 LED lighting spots. 1050 mA remote power supply not included.

2700K
■ 03.0055.14ANT
3000K
■ 03.0054.14ANT

2700K
■ 03.0057.14ANT
3000K
■ 03.0056.14ANT

Equipos recomendados:
Recommended power supply:

Non Dimmable 60.8548
Dimmable Dali 60.8549
Dim 1-10V / Dim Dali / Push 60.8530

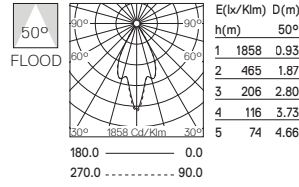
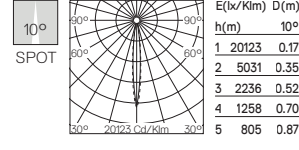

[THE BLACK LINE NO TRIM] 12 SPOTS

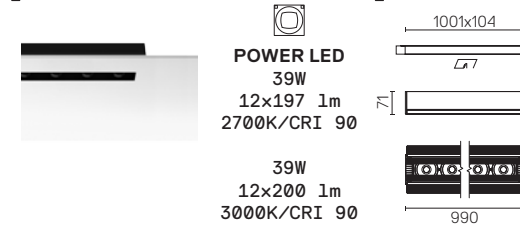

POWER LED
39W
12x197 1m
2700K/CRI 90

39W
12x200 1m
3000K/CRI 90

Luminaria empotrable de 12 focos LED. Fuente de alimentación remota de 1050 mA no incluida.

Recessed integrated luminaire with 12 LED lighting spots. 1050 mA remote power supply not included.

2700K
■ 03.0063.14ANT
3000K
■ 03.0062.14ANT

2700K
■ 03.0065.14ANT
3000K
■ 03.0064.14ANT

Equipos recomendados:
Recommended power supply:

Non Dimmable 60.8988
Dim 1-10V / Dim Dali / Push 60.8530

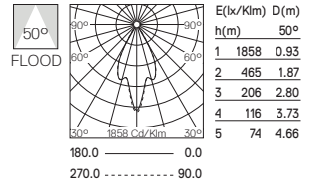
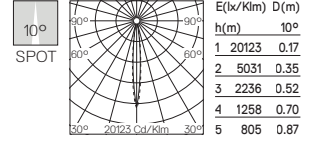

Detalle de interconexión para construir una línea continua
Interconnection information to build a continuous line

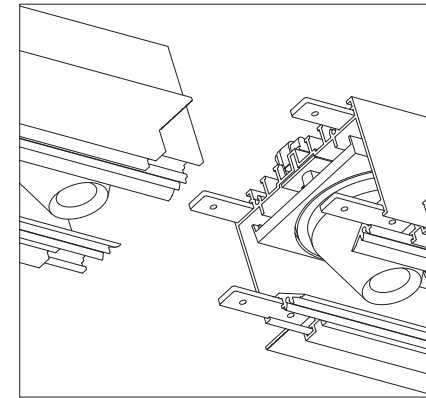

[La versión No Trim se puede interconectar para construir una línea continua.]
No Trim version can be connected in a continuous line.

[La versión No Trim se puede interconectar para construir una línea continua.]
No Trim version can be connected in a continuous line.

THE BLACK LINE

THE BLACK LINE TRIM 2 SPOTS

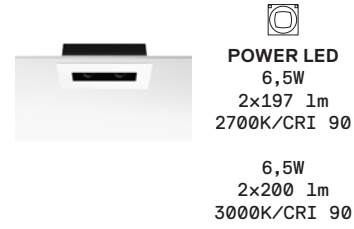

Equipos recomendados:
Recommended power supply:

Non Dimmable 60.8670
Dim 1-10V / Dim Dali / Push 60.8530



Luminaria empotrable de 2 focos LED. Fuente de alimentación remota de 1050 mA no incluida.

Recessed integrated luminaire with 2 LED lighting spots. 1050 mA remote power supply not included.

2700K
 03.0051.00
 03.0051.40
3000K
 03.0050.00A
 03.0050.40A

2700K
 03.0053.00
 03.0053.40
3000K
 03.0052.00A
 03.0052.40A

LED INCL.
NOT REPLACEABLE

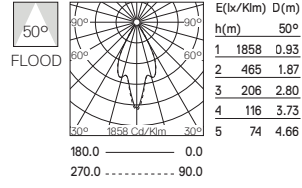
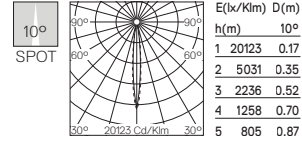

THE BLACK LINE

THE BLACK LINE TRIM 8 SPOTS

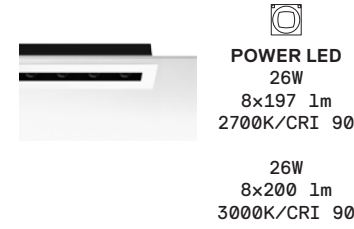

Equipos recomendados:
Recommended power supply:

Non Dimmable 60.8548
Dimmable Dali 60.8549
Dim 1-10V / Dim Dali / Push 60.8530



Luminaria empotrable de 8 focos LED. Fuente de alimentación remota de 1050 mA no incluida.

Recessed integrated luminaire with 8 LED lighting spots. 1050 mA remote power supply not included.

2700K
 03.0059.00
 03.0059.40
3000K
 03.0058.00A
 03.0058.40A

2700K
 03.0061.00
 03.0061.40
3000K
 03.0060.00A
 03.0060.40A

LED INCL.
NOT REPLACEABLE

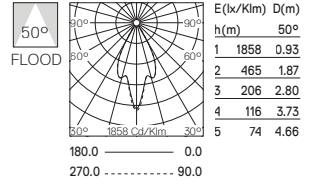
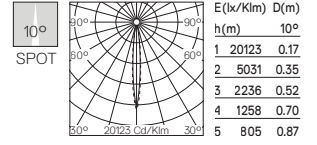

THE BLACK LINE TRIM 4 SPOTS

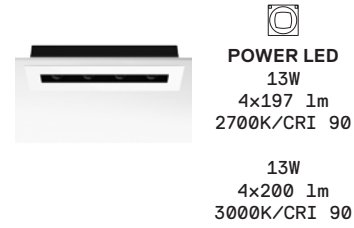

Equipos recomendados:
Recommended power supply:

Non Dimmable 60.8548
Dimmable Dali 60.8549
Dim 1-10V / Dim Dali / Push 60.8530



Luminaria empotrable de 4 focos LED. 1050 mA remote power supply not included.

Recessed integrated luminaire with 4 LED lighting spots. 1050 mA remote power supply not included.

2700K
 03.0055.00
 03.0055.40
3000K
 03.0054.00A
 03.0054.40A

2700K
 03.0057.00
 03.0057.40
3000K
 03.0056.00A
 03.0056.40A

LED INCL.
NOT REPLACEABLE

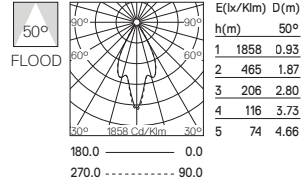
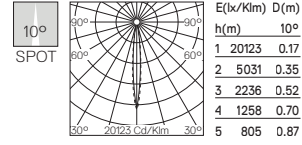

THE BLACK LINE TRIM 12 SPOTS

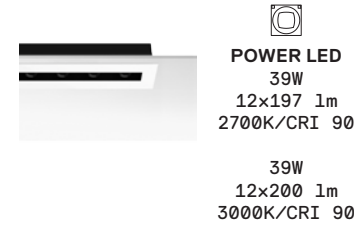

Equipos recomendados:
Recommended power supply:

Dim 1-10V / Dim Dali / Push 60.8530



Luminaria empotrable de 12 focos LED. Fuente de alimentación remota de 1050 mA no incluida.

Recessed integrated luminaire with 12 LED lighting spots. 1050 mA remote power supply not included.

2700K
 03.0063.00
 03.0063.40
3000K
 03.0062.00A
 03.0062.40A

2700K
 03.0065.00
 03.0065.40
3000K
 03.0064.00A
 03.0064.40A

LED INCL.
NOT REPLACEABLE

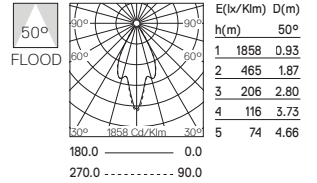
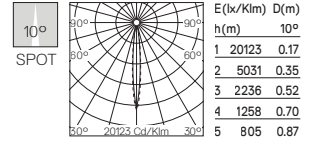



Conos de apantallamiento desmontables en silicona, que garantizan el confort visual y una completa accesibilidad a la electrónica después de la instalación.

Dismountable silicon screening cones to ensure visual comfort and a complete accessibility to the electronics after installation.

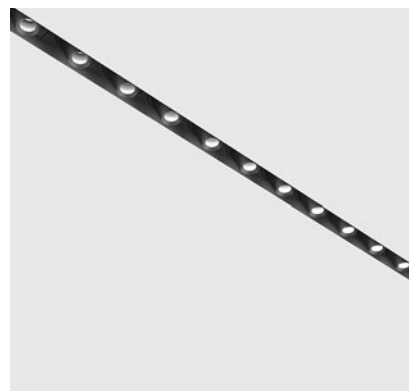

La versión No Trim puede componerse en un línea continua.

The No Trim version can be installed in a continuous line.





BON JOUR

Empotrables LED de diseño peculiar, gracias al pequeño borde que define la presencia de la luminaria. Disponible en tres tamaños, con diferentes ópticas para mayor personalización. Líneas puras acentuadas por los refinados acabados, en versiones neutras y metalizadas.

BON JOUR

Embedded LED with an unusual design, thanks to the small edge that defines the presence of the luminaire. Comes in three sizes with different optics for a better personalisation. Pure lines highlighted with the refined finishes, in neutral and metal plated versions.



DESIGNED BY PHILIPPE STARCK







Descripción

Luminaria LED para ser instalada en falso techo. Una vez instalado, el borde de la luminaria sobresale del techo 10 mm creando un efecto estético único y refinado. Cuerpo de la luminaria realizado en aluminio inyectado. Disponible en tres tamaños: Ø45 mm, Ø90 mm y Ø145 mm. Reflector de aluminio anodizado brillante con elemento difusor realizado en policarbonato. Disponible en los acabados: blanco (01), cromo (06), cobre (CU) y negro (14).

Unidades de Alimentación

Cableado incluido, diponible para conectar a equipo remoto. Versión Dali dimmable disponible. Versiones sin equipo y con equipo 110V disponibles bajo pedido.

Accesorios

- marco de instalación realizado en material termoplástico para su instalación en falso techo, necesario para las versiones Ø90 mm y Ø145 mm (no es necesario para la versión de Ø45 mm).
- accesorios honeycomb y cruceta de apantallamiento (incluidos en la versión de Ø45 mm).
- accesorios de apantallamiento disponibles para la versión ø145, con los mismos acabados que la luminaria Bon Jour decorativa. Ver el catálogo Flos "The Home Collection" para más detalles.

Información Adicional

Índice de protección IP44.
Clase de aislamiento II.

Cumplimiento de Normativa y Marcas de Calidad

Luminaria conforme con la Normativa Técnica Europea EN60598-1 y partes segundas.

Description

LED luminaire for recessed mounting on plasterboard ceilings. Once installed, the luminaire edge sticks out of the ceiling 10 mm creating a unique and very refined aesthetic effect. The luminaire's body is injected with aluminium. It is available in three sizes: Ø45 mm, Ø90 mm and Ø145 mm. Reflector made of anodized gloss aluminium with diffuser element made of polycarbonate. Available finishes: white (01), chrome (06), copper (CU) and black (14).

Power Supply

Cabling included, ready to be powered by included remote driver. Dali dimmable version available. Versions without driver and 110V driver available on request.

Accessories

- installation frame made from thermoplastic material for installation in suspended ceilings required for the Ø90 mm and Ø145 mm versions (not necessary for Ø45 mm version).
- honeycomb and cross screening cylinder (included for Ø45 mm version).
- screening accessories available for the ø145 version, with the same finishes as the decorative Bon Jour luminaire. See the Flos "The Home Collection" catalogue for more information.

Additional Information

IP44 protection grade.
Insulation class II.

Standard Compliance and Quality Marks

EN60598-1 European Technical Standards and any subsequent additions.

**Colores
Colours**

01 Blanco
01 White

06 Cromo
06 Chrome

CU Cobre
CU Copper

14 Negro
14 Black

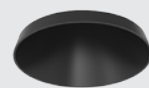

BON JOUR
Ø45



POWER LED
6W
575 lm
2700K/CRI 90
6W
615 lm
3000K/CRI 90

BON JOUR
Ø90



LED ARRAY
13,5W
1500 lm
2700K/CRI 90
13,5W
1600 lm
3000K/CRI 90

BON JOUR
Ø145



LED ARRAY
27W
2600 lm
2700K/CRI 90
27W
2720 lm
3000K/CRI 90

BON JOUR Ø45

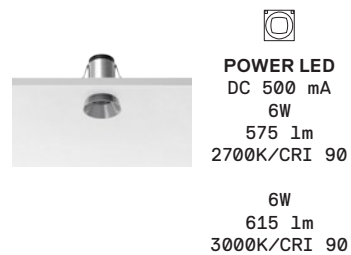

BON JOUR

Luminaria empotrable para fuente de luz LED. Fuente de alimentación remota 220/240V incluida.

Embedded luminaire for LED light source. Remote 220/240V power supply included.

- 2700K
Non Dimmable
 03.2001.01
Dali Version
 03.2001.01.DA
- 3000K
Non Dimmable
 03.2006.01
Dali Version
 03.2006.01.DA

- 2700K
Non Dimmable
 03.2001.06
Dali Version
 03.2001.06.DA
- 3000K
Non Dimmable
 03.2006.06
Dali Version
 03.2006.06.DA

- 2700K
Non Dimmable
 03.2001.CU
Dali Version
 03.2001.CU.DA

- 3000K
Non Dimmable
 03.2006.CU
Dali Version
 03.2006.CU.DA

- 2700K
Non Dimmable
 03.2001.14
Dali Version
 03.2001.14.DA

- 3000K
Non Dimmable
 03.2006.14
Dali Version
 03.2006.14.DA

Accesorios incluidos (honeycomb y cruceta de apantallamiento).

Accessories included (honeycomb and screening crosspiece).



BON JOUR Ø90

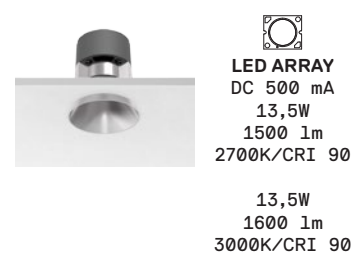

BON JOUR

Luminaria empotrable para fuente de luz LED. Fuente de alimentación remota 220/240V incluida.

Embedded luminaire for LED light source. Remote 220/240V power supply included.

- 2700K
Non Dimmable
 03.2003.01
Dali Version
 03.2003.01.DA
- 3000K
Non Dimmable
 03.2007.01
Dali Version
 03.2007.01.DA

- 2700K
Non Dimmable
 03.2003.06
Dali Version
 03.2003.06.DA
- 3000K
Non Dimmable
 03.2007.06
Dali Version
 03.2007.06.DA

- 2700K
Non Dimmable
 03.2003.CU
Dali Version
 03.2003.CU.DA

- 3000K
Non Dimmable
 03.2007.CU
Dali Version
 03.2007.CU.DA

- 2700K
Non Dimmable
 03.2003.14
Dali Version
 03.2003.14.DA

- 3000K
Non Dimmable
 03.2007.14
Dali Version
 03.2007.14.DA

Marco de pre-instalación. Se ha de pedir por separado.

Pre-installation frame must be ordered separately.



BON JOUR Ø145



LED ARRAY
 DC 900 mA
 27W
 2600 lm
 2700K/CRI 90

27W
 2720 lm
 3000K/CRI 90

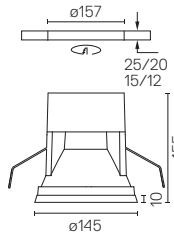

Luminaria empotrable para fuente de luz LED. Fuente de alimentación remota 220/240V incluida.

Embedded luminaire for LED light source. Remote 220/240V power supply included.

- 2700K
 Non Dimmable
 03.2005.01
 Dali Version
 03.2005.01.DA
- 3000K
 Non Dimmable
 03.2008.01
 Dali Version
 03.2008.01.DA

- 2700K
 Non Dimmable
 03.2005.06
 Dali Version
 03.2005.06.DA

- 3000K
 Non Dimmable
 03.2008.06
 Dali Version
 03.2008.06.DA

- 2700K
 Non Dimmable
 03.2005.CU
 Dali Version
 03.2005.CU.DA

- 3000K
 Non Dimmable
 03.2008.CU
 Dali Version
 03.2008.CU.DA

- 2700K
 Non Dimmable
 03.2005.14
 Dali Version
 03.2005.14.DA

- 3000K
 Non Dimmable
 03.2008.14
 Dali Version
 03.2008.14.DA

Marco de pre-instalación. Se ha de pedir por separado.

Pre-installation frame must be ordered separately.

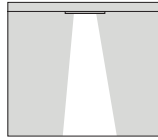

LED INCL.
 NOT REPLACEABLE

CE, F, IP 44, 1.11 Kg, PENDING, GWT 850°, h=215 min

BON JOUR
 ACCESORIOS / ACCESSORIES

Bon Jour Ø90

Marco de pre-instalación. 08.8974.00

Pre-installation frame.

Honeycomb y cruceta de apantallamiento. 08.8976.14

Honeycomb and screening crosspiece.

Bon Jour Ø145

Marco de pre-instalación. 08.8975.00

Pre-installation frame.

Honeycomb y cruceta de apantallamiento. 08.8980.14

Honeycomb and screening crosspiece.

Accesorio decorativo de apantallamiento. 08.8977.00

Decorative screening accessory. 08.8978.00

08.8979.00

INSTALACIÓN SISTEMA FAST&PERFECT

Exclusivo sistema de instalación Flos para downlight sin marco. Sierra patentada para realizar rápidos y precisos agujeros circulares de doble nivel. Resultado uniforme en todas las instalaciones, incluso en casos en los que las placas de yeso son de espesor desigual. Gracias a los marcos de instalación específicos, este sistema es aplicable tanto para versiones cuadradas como redondas. Reduce el tiempo de instalación hasta un 50%.

Flos exclusive installation system for trimless downlights. Patented round hole saw to drill quick and precise double level installation holes. Uniform results throughout out the whole installation, even in the case of uneven plasterboard thickness. Thanks to specific installation rings, this system applies to both round and square downlights, and can be installed up to 50% faster.

Marcos de instalación disponibles para downlight sin marco: redondos y cuadrados:
Installation ring available for round and square trimless downlights:

- Kap 80 (Round/Square)
- Kap 105 (Round)
- Johnny 80 (Round/Square)



FAST&PERFECT INSTALLATION SYSTEM

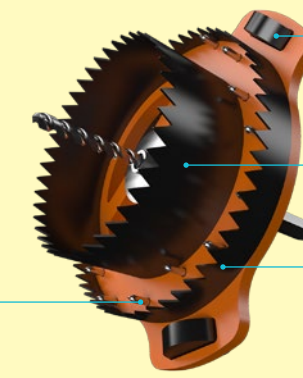

Dientes de escalonado de acero: diseño de los dientes desarrollados para facilitar la eliminación de los restos del corte de cartón-yeso.

Stepped steel teeth: this design facilitates the removal of any cutting remains from the plasterboard.

Herramienta exclusiva y patentada. Compatible con taladros estándar. Garantizado para un mínimo de 300 cortes.

Exclusive and patented tool. Compatible with standard drilling machines. Guaranteed for minimum 300 cuts.

Ruedas espaciadoras para asegurar una rebaja constante del borde. Misma perforación y resultado incluso en placas de yeso de distinto espesor.

Spacer wheels to ensure constant rebate edge. The drill and installation have the same result when used with with different plasterboard thickness.

Doble sierra circular de acero inoxidable con dientes especialmente diseñados para cortar cartón yeso y papel.

Double stainless steel round saw: unset teeth with negative edges, specially designed to cut plasterboard and paper layers.



STEP 1

Perforación de la placa de yeso con la herramienta Flos para obtener un orificio rodeado por un anillo de profundidad constante.

Plasterboard drilling with Flos tool to obtain a hole surrounded by a milled ring with an even thickness.

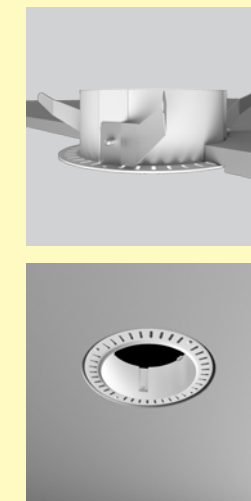

STEP 2

Fácil instalación del marco de pre-instalación en el orificio, para ser pegado o atornillado a la placa de yeso.

Easy installation of the trimless frame in the hole: glued or screwed to plasterboard.

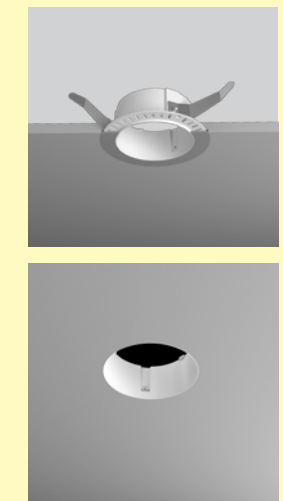

STEP 3

Acabado con yeso para cubrir el marco.

Plasterboard finish covering the frame.

Productos con sistema de instalación Fast&Perfect / Products with Fast&Perfect Installation System





KAP

Colección de empotrables para instalaciones de interior, que incluye soluciones tanto en LED de última generación como luminarias con fuente de luz tradicional. Extensa variedad de tamaños y acabados que garantiza su perfecta integración en todos los ambientes. Cuerpo óptico diseñado para garantizar un gran confort visual. Incluye versiones para instalación rápida sin marco con sistema Fast&Perfect.

KAP

A collection of embedded elements for interior installations that include avant-garde LED solutions and luminaires with a traditional light source. A wide variety of sizes and finishes that ensure a perfect integration in all environments. Optic body to ensure an excellent visual comfort. Includes different versions for a fast frame-free installation with the Fast&Perfect system.

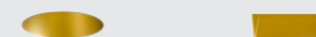

DESIGNED BY FLOS ARCHITECTURAL





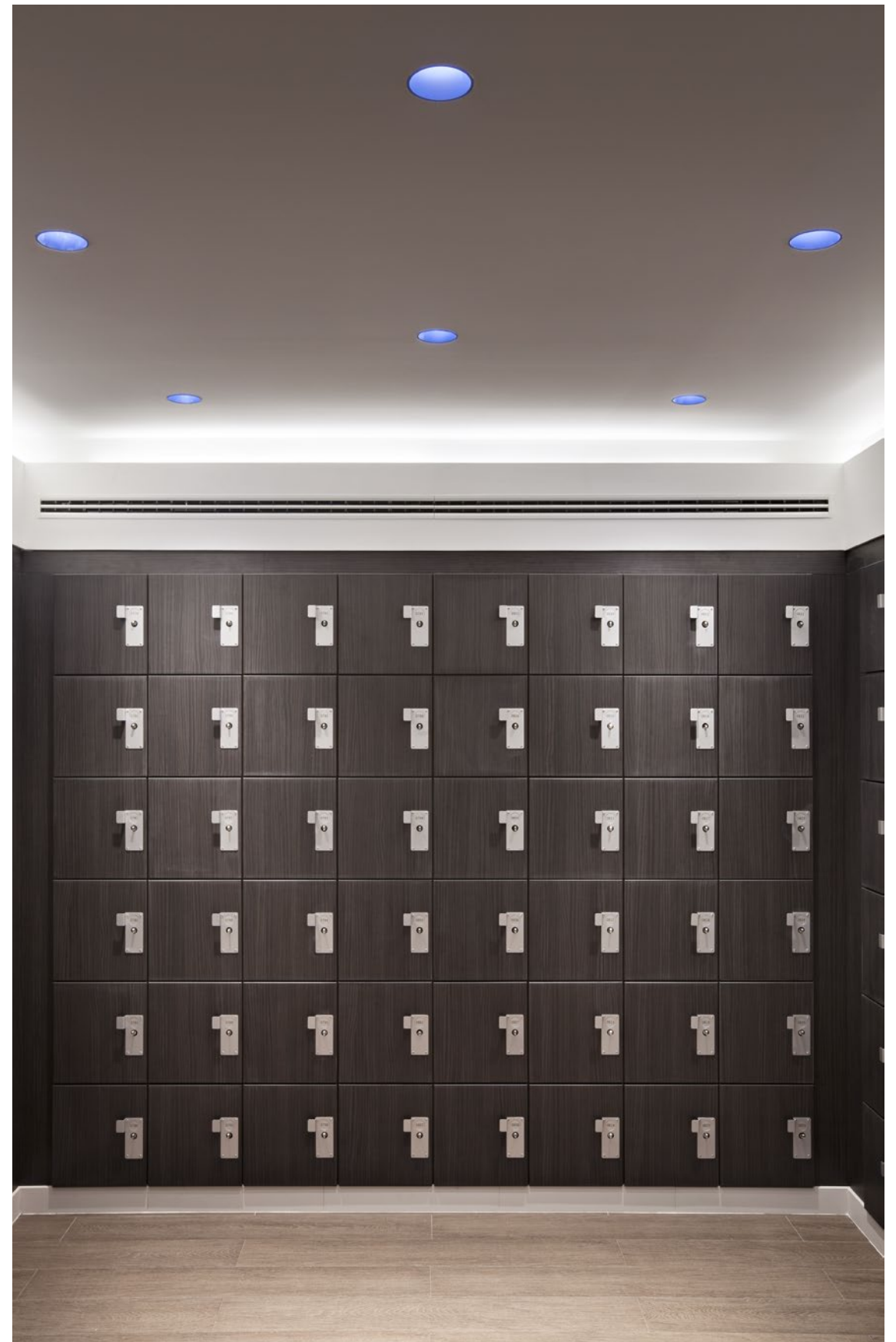

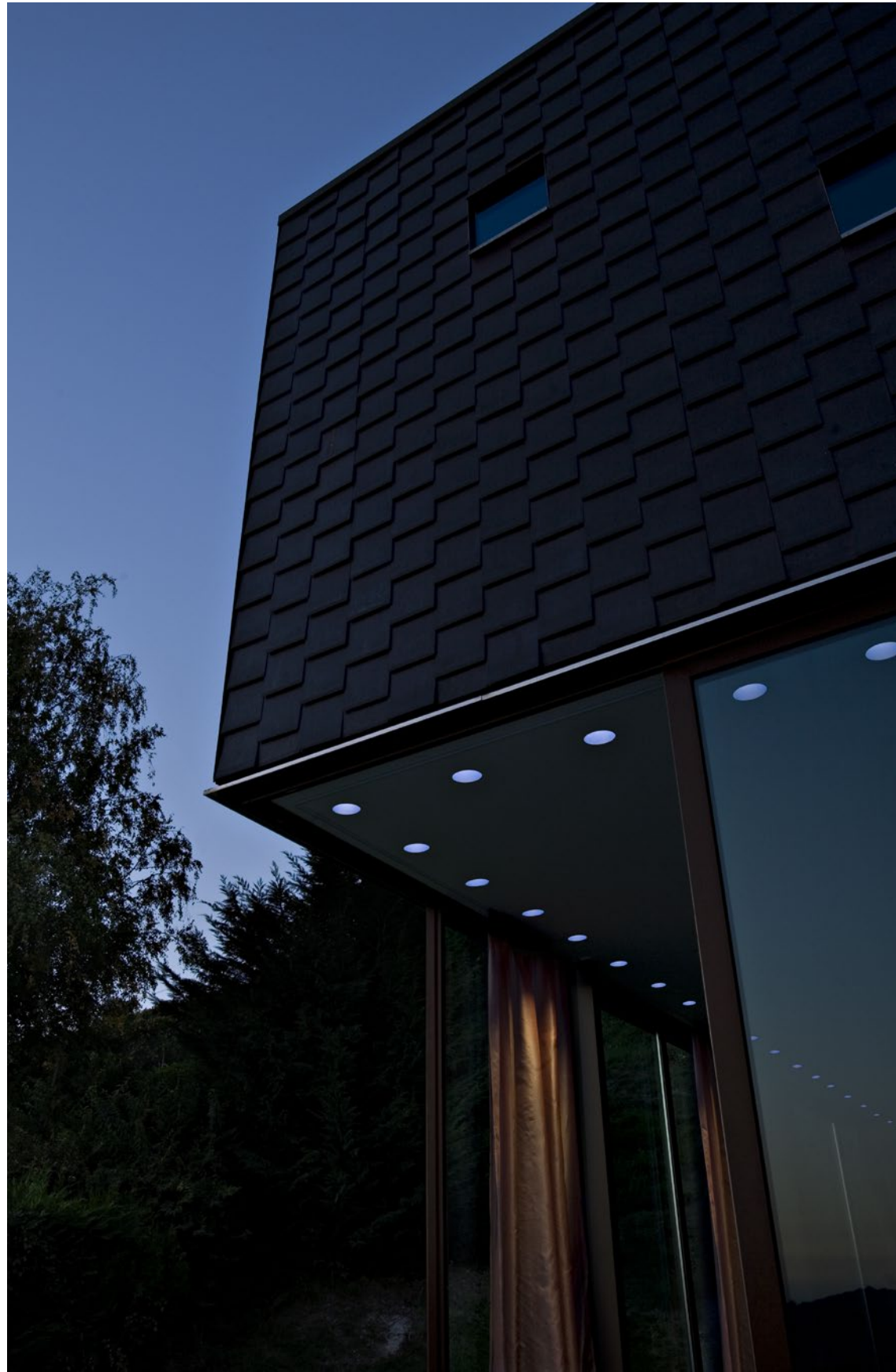

EASY KAP

Descripción

Luminaria para ser instalada empotrada en techos para lámparas halógenas, de halogenuro metálico y LED.

La versión Easy Kap dispone de cuerpo inyectado en zamak para la versión de 105mm y de aluminio para la versión de 80mm, con acabado en pintura líquida, polvo y/o cobre metalizado con cristal difusor opal incluido. No necesita pre-marco de instalación.

Portalámparas con elemento disipador en aluminio inyectado y aro de empotramiento del cuerpo óptico en material termoplástico.

Disponible en los acabados: blanco (B1), oro mate (GL), azul (BU), negro (74) y cobre (CU).

Unidades de Alimentación

Easy Kap 80 / 105 LED y Kap 80 equipo remoto no incluido. Conexión rápida, tipo "Wieland", con la unidad de alimentación para lámparas de descarga.

Información Adicional

Índice de protección IP20, IP23, IP43, IP44, según las versiones.

Clase de aislamiento I, II, III, según las versiones.

Cumplimiento de Normativa y Marcas de Calidad

Luminaria conforme con la Normativa Técnica Europea EN60598-1 y partes segundas.

Description

Luminaire for embedded installation in ceilings for halogen lamps, meta-halide lamps and LEDs.

The Easy Kap version has a Zamak injected body for the 105 mm version and steel for the 80 mm version, with a liquid paint, dust and/or metallic copper finish with a glass or plastic diffuser depending on the version. It does not need a pre-installation frame.

Lamp holder with a dissipating element in injected aluminium and a thermoplastic embedding ring for the optic body.

Available finishes: white (B1), matt gold (GL), blue (BU), black (74) and copper (CU).

Power Supply

Remote Easy Kap 80 / 105 LED and Kap 80 equipment not included.

Fast connection of the "Wieland" type with the power supply units for discharge lamps.

Additional Information

IP20, IP23, IP43, IP44 protection grade depending on the versions.

Insulation class I, II, III depending on the versions.

Standard Compliance and Quality Marks

EN60598-1 European Technical Standards and any subsequent additions.

Colores Colours

□ B1 Blanco
B1 White

■ GL Oro Mate
GL Matt Gold

■ BU Azul
BU Blue

■ 74 Negro
74 Black

■ CU Cobre
CU Copper



EASY KAP

EASY KAP 80 FIXED



LED ARRAY
9,2W
698 1m
2700K/CRI 90
810 1m
3000K/CRI 90



QR-CBC 51
GX5.3
MAX 50W
- OR -
LED QR-CBC 51
MAX 8W



PAR 16
GZ10
MAX 50W
- OR -
LED PAR 16
MAX 8W

EASY KAP 80 ADJUSTABLE



LED ARRAY
9,2W
698 1m
2700K/CRI 90
810 1m
3000K/CRI 90



LED QR-CBC 51
MAX 8W



LED PAR 16
MAX 8W

EASY KAP 80 WALL-WASHER



LED ARRAY
9,2W
698 1m
2700K/CRI 90
810 1m
3000K/CRI 90



QR-CBC 51
GX5.3
MAX 50W
- OR -
LED QR-CBC 51
MAX 8W



PAR 16
GZ10
MAX 50W
- OR -
LED PAR 16
MAX 8W

EASY KAP Ø105 FIXED



LED ARRAY
9,2W
698 1m
2700K/CRI 90
945 1m
3000K/CRI 80



QR-CBC 51
GX5.3
MAX 50W
- OR -
LED QR-CBC 51
7W



HI PAR 51
GX10
MAX 35W

EASY KAP Ø105 WALL- WASHER



LED ARRAY
9,2W
698 1m
2700K/CRI 90
945 1m
3000K/CRI 80



QR-CBC 51
GX5.3
MAX 50W
- OR -
LED QR-CBC 51
7W



HI PAR 51
GX10
MAX 35W

Descripción

Luminaria para ser instalada empotrada en techos para lámparas halógenas, de halogenuro metálico y LED. La versión Kap dispone de cuerpo inyectado en aluminio con acabado en pintura líquida y cobre metalizado. Está disponible en tres diámetros: 80 mm, 105 mm y 145 mm. Óptica principal realizada en aluminio anodizado brillo con elemento difusor realizado en cristal o plástico dependiendo de versiones. Portalámparas con elemento disipador en aluminio inyectado y aro de empotramiento del cuerpo óptico en material termoplástico. Sistema de instalación Fast&Perfect para las versiones Kap 80 round y square y 105 round. Disponible en los acabados: blanco (B1), oro mate (GL), azul (BU), negro (74) y cobre (CU).

Unidades de Alimentación

Easy Kap 80 / 105 LED y Kap 80 equipo remoto no incluido. Kap 105 / 145 LED equipo remoto incluido. Conexión rápida, tipo "Wieland", con la unidad de alimentación para lámparas de descarga.

Accesorios

Pre-marco de instalación y herramienta Fast&Perfect para las versiones Kap 80 redondo y cuadrado y 105 redondo. Disponibles can para instalación en cemento.

Información Adicional

Índice de protección IP20, IP23, IP43, IP44, según las versiones. Clase de aislamiento I, II, III, según las versiones. - KAP 80 / 105 / 145: Gracias a la remote-phosphor technology, los módulos LED que montan las versiones Phosphor LED ofrecen la máxima calidad de luz posible, percepción de los objetos y espacios, alcanzando índices de reproducción cromática de 98, dependiendo de las versiones. Los módulos LED instalados en las versiones LED Array cuentan con la última generación tecnológica que permite una menor temperatura media en el funcionamiento de la electrónica. Gracias a esta característica, la luminaria puede operar dentro de parámetros de seguridad a una mayor potencia, ofreciendo una aumento del 20% del flujo luminoso.

Cumplimiento de Normativa y Marcas de Calidad

Luminaria conforme con la Normativa Técnica Europea EN60598-1 y partes segundas.

Description

Luminaire for embedded installation in ceilings for halogen lamps, meta-halide lamps and LEDs. The Kap version has an aluminium-injected body with a liquid paint and metallic copper finish. Available in three diameters: 80 mm, 105 mm and 145 mm. Main optics in shiny anodised aluminium with a glass or plastic diffuser element, depending on the version. Lamp holder with a dissipating element in injected aluminium and a thermoplastic embedding ring for the optic body. Fast&Perfect installation system for the round and square versions of the Kap 80 and round 105. Available finishes: white (B1), matt gold (GL), blue (BU), black (74) and copper (CU).

Power Supply

Remote Easy Kap 80 / 105 LED and Kap 80 equipment not included. Remote Kap 105 / 145 LED equipment included. Fast connection of the "Wieland" type with the power supply units for discharge lamps.

Accessories

Pre-installation frame and Fast&Perfect tool for the round and square Kap 80 and round 105 version. Available for installation on cement.

Additional Information

IP20, IP23, IP43, IP44 protection grade depending on the versions. Insulation class I, II, III depending on the versions. - KAP 80 / 105 / 145: Thanks to remote-phosphor technology, the LED modules of the Phosphor LED version offer maximum quality light, the perception of objects and spaces, reaching chromatic reproduction indices of 98, depending on the version. The LED modules installed on the LED Array versions have cutting-edge technology that permits a lower average temperature in the electronics. Thanks to this feature, the luminaire can operate at a higher power inside the safety parameters yet still offer 20% added luminous flux.

Standard Compliance and Quality Marks

EN60598-1 European Technical Standards and any subsequent additions.

Colores **Colours** B1 Blanco B1 White GL Oro Mate GL Matt Gold BU Azul BU Blue 74 Negro 74 Black CU Cobre CU Copper



KAP 80 FIXED



LED ARRAY
9,2W
698 lm
2700K/CRI 90
810 lm
3000K/CRI 90

KAP 80 ADJUSTABLE



QR-CBC 51
GX5.3
*MAX 50W
- OR -
LED QR-CBC 51
MAX 8W

KAP 80 WALL-WASHER

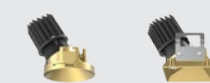

PAR 16
GZ10
*MAX 50W
- OR -
LED PAR 16
MAX 8W

* Only Fixed / Wall-Washer version

KAP Ø105



PHOSPHOR LED
15,6W
1300 lm
2700K/CRI 98
11,7W
1300 lm
3000K/CRI 80

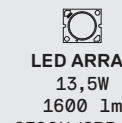

LED ARRAY
13,5W
1600 lm
2700K/CRI 90
13,5W
1650 lm
3000K/CRI 90

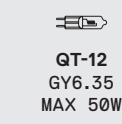

QT-12
GY6.35
MAX 50W

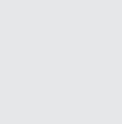

CDM-TC
G8.5
MAX 35W

KAP 105 SQUARE



PHOSPHOR LED
15,6W
1300 lm
2700K/CRI 98
11,7W
1300 lm
3000K/CRI 80

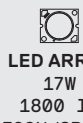

LED ARRAY
17W
1800 lm
2700K/CRI 90
17W
2000 lm
3000K/CRI 90

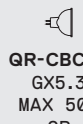

QR-CBC 51
GX5.3
MAX 50W
- OR -
LED QR-CBC 51
7W

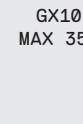

HI PAR 51
GX10
MAX 35W

KAP Ø145



PHOSPHOR LED
17W
1400 lm
2700K/CRI 98
19,5W
2000 lm
3000K/CRI 80

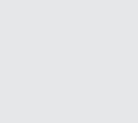

LED ARRAY
17W
1800 lm
2700K/CRI 90
17W
2000 lm
3000K/CRI 90

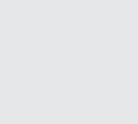

QT-12
GY6.35
MAX 65W IRC

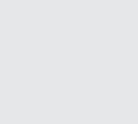

CDM-TC
G8.5
MAX 70W

KAP Ø145 DEEP



PHOSPHOR LED
17W
1400 lm
2700K/CRI 98
19,5W
2000 lm
3000K/CRI 80

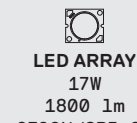

LED ARRAY
17W
1800 lm
2700K/CRI 90
17W
2000 lm
3000K/CRI 90

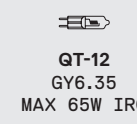

QT-12
GY6.35
MAX 65W IRC

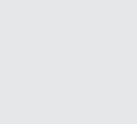

CDM-TC
G8.5
MAX 70W

KAP Ø145 WALL-WASHER



PHOSPHOR LED
17W
1400 lm
2700K/CRI 98
19,5W
2000 lm
3000K/CRI 80

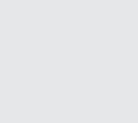

LED ARRAY
17W
1800 lm
2700K/CRI 90
17W
2000 lm
3000K/CRI 90

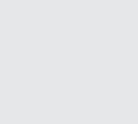

QT-12
GY6.35
MAX 65W IRC

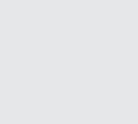

CDM-TC
G8.5
MAX 70W

KAP

EASY KAP Ø80 FIXED



LED ARRAY
DC 500 mA
9,2W
698 lm
2700K/CRI 90

9,2W
810 lm
3000K/CRI 90

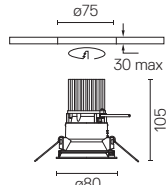

Empotrable para fuente de luz LED. Fuente de alimentación no incluida. Marco de instalación no necesario.

Embedded light fixture for LED light source. Power supply not included. Installation frame not necessary.

2700K
□ 03.4193.B1
3000K
□ 03.4192.B1

2700K
■ 03.4193.GL
3000K
■ 03.4192.GL

2700K
■ 03.4193.BU
3000K
■ 03.4192.BU

Lente difusora incluida.
Diffusing lens included.

Equipos recomendados:
Recommended power supply:

Non Dimmable 60.8880
Dimmable 1-10V 60.8533
Dimmable Dali 60.8530
Mains Dimming 60.8534

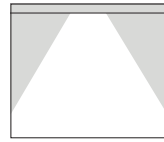

LED INCL.
NOT REPLACEABLE



2700K
■ 03.4193.CU
3000K
■ 03.4192.CU

2700K
□ 03.4195.B1
3000K
□ 03.4194.B1

2700K
■ 03.4195.GL
3000K
■ 03.4194.GL

2700K
■ 03.4195.BU
3000K
■ 03.4194.BU

Lente difusora incluida.
Diffusing lens included.

Equipos recomendados:
Recommended power supply:

Non Dimmable 60.8880
Dimmable 1-10V 60.8533
Dimmable Dali 60.8530
Mains Dimming 60.8534

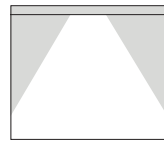

LED INCL.
NOT REPLACEABLE



2700K
■ 03.4195.CU
3000K
■ 03.4194.CU

KAP

EASY KAP Ø80 FIXED



QR-CBC 51
GX5.3
MAX 50W

-OR-

LED
QR-CBC 51
GX5.3
MAX 8W

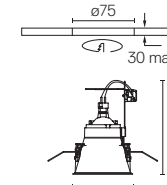

Empotrable para lámpara halógena de 12V. Transformador remoto no incluido. Marco de instalación no necesario.

12V halogen lamp recessed downlight. Remote transformer not included. Installation frame not necessary.

□ 03.4210.B1

■ 03.4210.GL

■ 03.4210.BU

■ 03.4210.74

■ 03.4210.CU



EASY KAP 80 SQUARE FIXED



QR-CBC 51
GX5.3
MAX 50W

-OR-

LED
QR-CBC 51
GX5.3
MAX 8W

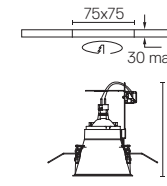

Empotrable para lámpara halógena de 12V. Transformador remoto no incluido. Marco de instalación no necesario.

12V halogen lamp recessed downlight. Remote transformer not included. Installation frame not necessary.

□ 03.4208.B1

■ 03.4208.GL

■ 03.4208.BU



■ 03.4208.74

■ 03.4208.CU



KAP

EASY KAP Ø80 FIXED

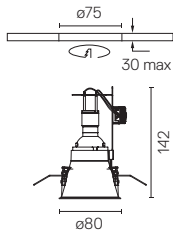

PAR 16 GZ10
 MAX 50W
 - OR -

LED PAR 16 GZ10
 MAX 8W





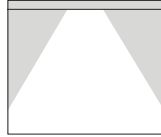







Empotrable con alimentación directa a red. Marco de instalación no necesario.



Recessed downlight with main voltage source. Installation frame not necessary.

- 03.4211.B1
- 03.4211.GL
- 03.4211.BU
- 03.4211.74
- 03.4211.CU



EASY KAP 80 SQUARE FIXED

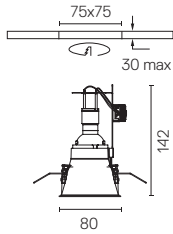

PAR 16 GZ10
 MAX 50W
 - OR -

LED PAR 16 GZ10
 MAX 8W





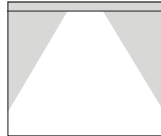







Empotrable con alimentación directa a red. Marco de instalación no necesario.

Recessed downlight with main voltage source. Installation frame not necessary.

- 03.4209.B1
- 03.4209.GL
- 03.4209.BU
- 03.4209.74
- 03.4209.CU



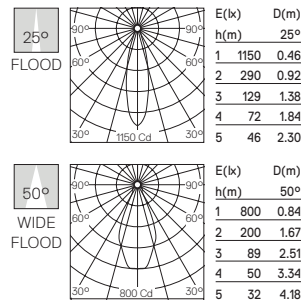

EASY KAP Ø80 ADJUSTABLE

LED ARRAY DC 500 mA
 9,2W
 698 lm
 2700K/CRI 90
 - OR -
 9,2W
 810 lm
 3000K/CRI 90

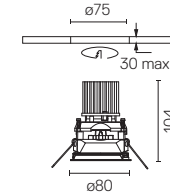

Empotrable para fuente de luz LED. Fuente de alimentación no incluida. Marco de instalación no necesario.

Embedded light fixture for LED light source. Power supply not included. Installation frame not necessary.

- 2700K
- 03.4155.B1
- 3000K
- 03.4171.B1

- 2700K
- 03.4155.GL
- 3000K
- 03.4171.GL

- 2700K
- 03.4155.BU
- 3000K
- 03.4171.BU

- 2700K
- 03.4155.74
- 3000K
- 03.4171.74

- 2700K
- 03.4155.CU
- 3000K
- 03.4171.CU

Lente difusora incluida. Diffusing lens included.

Equipos recomendados: Recommended power supply:

- Non Dimmable 60.8880
- Dimmable 1-10V 60.8533
- Dimmable Dali 60.8530
- Mains Dimming 60.8534

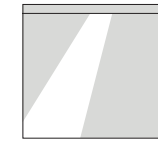

LED INCL. NOT REPLACEABLE









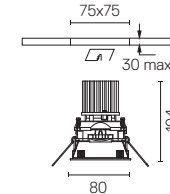

EASY KAP 80 SQUARE ADJUSTABLE

LED ARRAY DC 500 mA
 9,2W
 698 lm
 2700K/CRI 90
 - OR -
 9,2W
 810 lm
 3000K/CRI 90



Empotrable para fuente de luz LED. Fuente de alimentación no incluida. Marco de instalación no necesario.

Embedded light fixture for LED light source. Power supply not included. Installation frame not necessary.

- 2700K
- 03.4201.B1
- 3000K
- 03.4200.B1

- 2700K
- 03.4201.GL
- 3000K
- 03.4200.GL

- 2700K
- 03.4201.BU
- 3000K
- 03.4200.BU

- 2700K
- 03.4201.74
- 3000K
- 03.4200.74

- 2700K
- 03.4201.CU
- 3000K
- 03.4200.CU

Lente difusora incluida. Diffusing lens included.

Equipos recomendados: Recommended power supply:

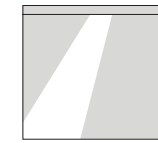

- Non Dimmable 60.8880
- Dimmable 1-10V 60.8533
- Dimmable Dali 60.8530
- Mains Dimming 60.8534



LED INCL. NOT REPLACEABLE











KAP

EASY KAP Ø80 ADJUSTABLE

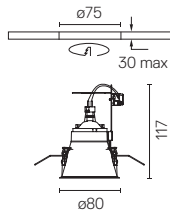

LED
QR-CBC 51
GX5.3
MAX 8W



Empotrable para lámpara halógena de 12V. Transformador remoto no incluido. Marco de instalación no necesario.

12V halogen lamp recessed downlight. Remote transformer not included. Installation frame not necessary.

03.4160.B1

03.4160.GL

03.4160.BU

03.4160.74

03.4160.CUA

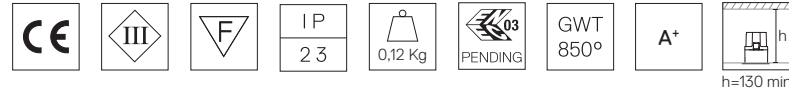

EASY KAP 80 SQUARE ADJUSTABLE



LED
QR-CBC 51
GX5.3
MAX 8W

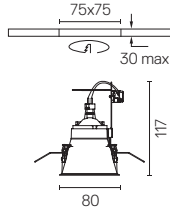

Empotrable para lámpara halógena de 12V. Transformador remoto no incluido. Marco de instalación no necesario.

12V halogen lamp recessed downlight. Remote transformer not included. Installation frame not necessary.

03.4212.B1

03.4212.GL

03.4212.BU

03.4212.74

03.4212.CU

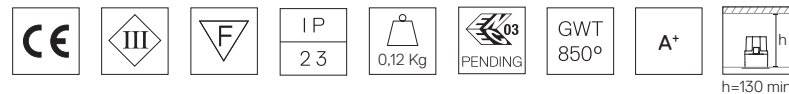

KAP

EASY KAP Ø80 ADJUSTABLE



LED
PAR 16
GZ10
MAX 8W

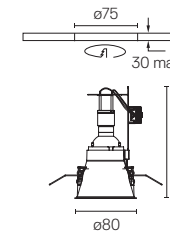

Empotrable con alimentación directa a red. Marco de instalación no necesario.

Recessed downlight with main voltage source. Mounting frame not required.

03.4162.B1
03.4162.GL
03.4162.BU
03.4162.74
03.4162.CU

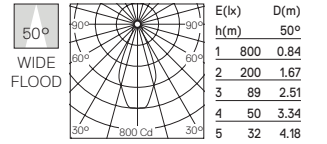
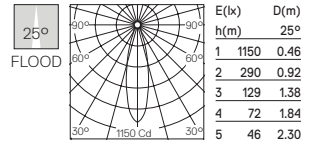
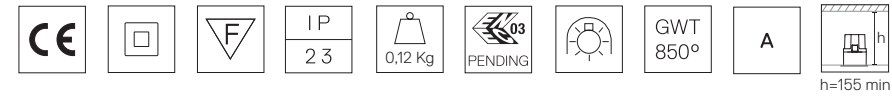

EASY KAP 80 SQUARE ADJUSTABLE



LED
PAR 16
GZ10
MAX 8W

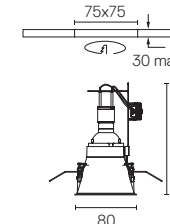

Empotrable con alimentación directa a red. Marco de instalación no necesario.

Recessed downlight with main voltage source. Mounting frame not required.

03.4213.B1
03.4213.GL
03.4213.BU
03.4213.74
03.4213.CU

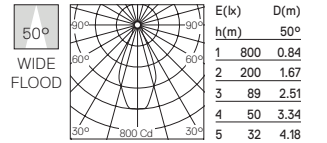
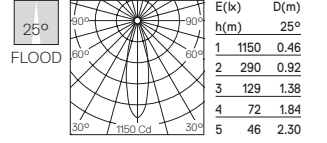
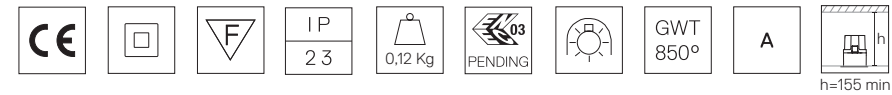
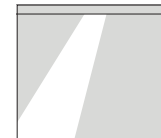

KAP

EASY KAP Ø80 WALL-WASHER

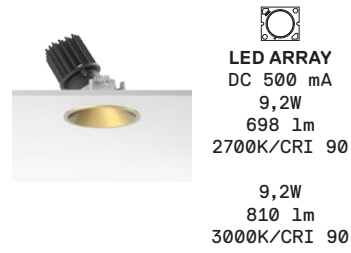

LED ARRAY
DC 500 mA
9,2W
698 lm
2700K/CRI 90

9,2W
810 lm
3000K/CRI 90

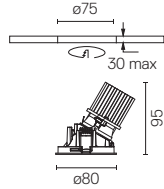

Empotrable para fuente de luz LED. Marco de instalación no necesario. Fuente de alimentación no incluida.

Embedded light fixture for LED light source. Mounting frame not required. Power supply not included.

- 2700K
 03.4197.B1
 3000K
 03.4196.B1
- 2700K
 03.4197.GL
 3000K
 03.4196.GL

- 2700K
 03.4197.BU
 3000K
 03.4196.BU

Lente difusora incluida.
Diffusing lens included.

Equipos recomendados:
Recommended power supply:

- Non Dimmable 60.8880
 Dimmable 1-10V 60.8533
 Dimmable Dali 60.8530
 Mains Dimming 60.8534

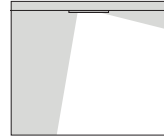

LED INCL.
NOT REPLACEABLE



- 2700K
 03.4197.74
 3000K
 03.4196.74

- 2700K
 03.4197.CU
 3000K
 03.4196.CU

EASY KAP 80 SQUARE WALL-WASHER

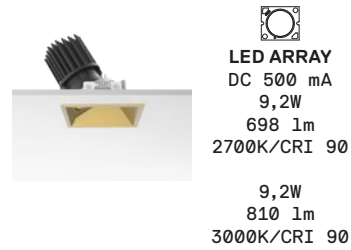

LED ARRAY
DC 500 mA
9,2W
698 lm
2700K/CRI 90

9,2W
810 lm
3000K/CRI 90

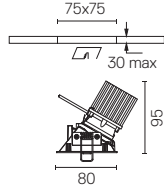

Empotrable para fuente de luz LED. Marco de instalación no necesario. Fuente de alimentación no incluida.

Embedded light fixture for LED light source. Mounting frame not required. Power supply not included.

- 2700K
 03.4199.B1
 3000K
 03.4198.B1
- 2700K
 03.4199.GL
 3000K
 03.4198.GL

- 2700K
 03.4199.BU
 3000K
 03.4198.BU

Lente difusora incluida.
Diffusing lens included.

Equipos recomendados:
Recommended power supply:

- Non Dimmable 60.8880
 Dimmable 1-10V 60.8533
 Dimmable Dali 60.8530
 Mains Dimming 60.8534

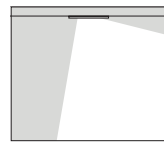

LED INCL.
NOT REPLACEABLE



- 2700K
 03.4199.74
 3000K
 03.4198.74

- 2700K
 03.4199.CU
 3000K
 03.4198.CU

KAP

EASY KAP Ø80 WALL-WASHER

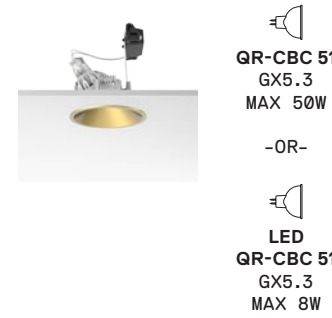

QR-CBC 51
GX5.3
MAX 50W

-OR-

LED
QR-CBC 51
GX5.3
MAX 8W

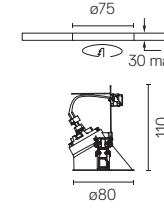

Empotrable para lámpara halógena de 12V. Transformador remoto no incluido. Marco de instalación no necesario.

12V halogen lamp recessed downlight. Remote transformer not included. Installation frame not necessary.

- 03.4220.B1
- 03.4220.GL

- 03.4220.BU

- 03.4220.74

- 03.4220.CU

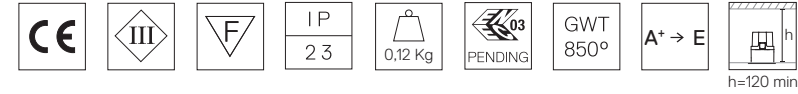

EASY KAP 80 SQUARE WALL-WASHER

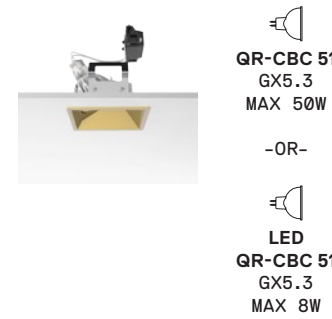

QR-CBC 51
GX5.3
MAX 50W

-OR-

LED
QR-CBC 51
GX5.3
MAX 8W

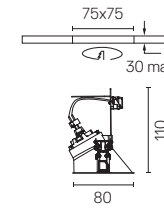

Empotrable para lámpara halógena de 12V. Transformador remoto no incluido. Marco de instalación no necesario.

12V halogen lamp recessed downlight. Remote transformer not included. Installation frame not necessary.

- 03.4218.B1
- 03.4218.GL

- 03.4218.BU

- 03.4218.74

- 03.4218.CU

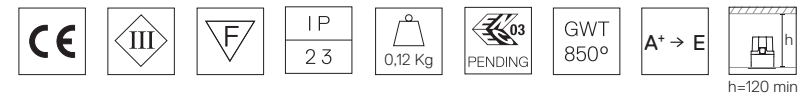

KAP

EASY KAP Ø80 WALL-WASHER



PAR 16
GZ10
MAX 50W

- OR -

LED
PAR 16
GZ10
MAX 8W

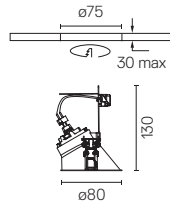

Empotrable con alimentación directa a red. Marco de instalación no necesario.

Recessed downlight with main voltage source. Mounting frame not required.

03.4221.B1
03.4221.GL
03.4221.BU
03.4221.74
03.4221.CU

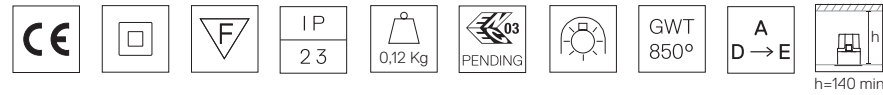
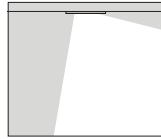

EASY KAP 80 SQUARE WALL-WASHER



PAR 16
GZ10
MAX 50W

- OR -

LED
PAR 16
GZ10
MAX 8W

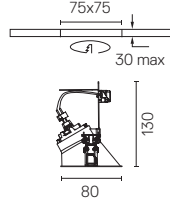

Empotrable con alimentación directa a red. Marco de instalación no necesario.

Recessed downlight with main voltage source. Mounting frame not required.

03.4219.B1
03.4219.GL
03.4219.BU
03.4219.74
03.4219.CU

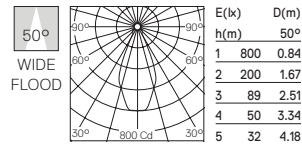
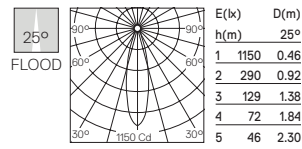
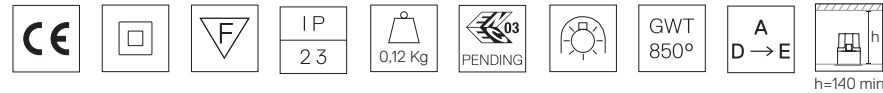
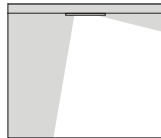

EASY KAP Ø105 FIXED



LED ARRAY
DC 500 mA
9,2W
698 lm
2700K/CRI 90

9,2W
945 lm
3000K/CRI 80

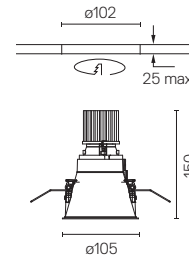

Empotrable para fuente de luz LED. Marco de instalación no necesario. Fuente de alimentación no incluida.

Embedded light fixture for LED light source. Mounting frame not required. Power supply not included.

2700K
03.4492.B1B
3000K
03.4462.B1B

2700K
03.4492.GLB
3000K
03.4462.GLB

2700K
03.4492.BUB
3000K
03.4462.BUB

2700K
03.4492.74B
3000K
03.4462.74B

2700K
03.4492.CUB
3000K
03.4462.CUB

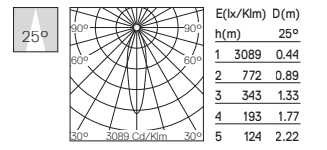
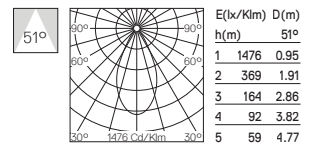
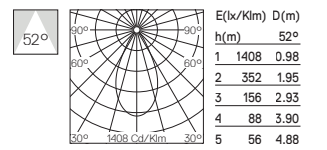
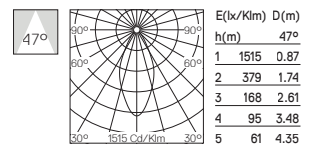
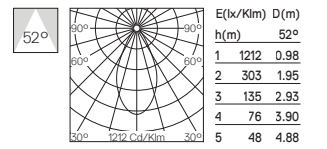

Equipos recomendados:
Recommended power supply:

Non Dimmable 60.8650
Dimmable 1-10V 60.8533
Dimmable Dali 60.8530
Mains Dimming 60.8534

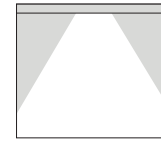

EASY KAP Ø105 FIXED

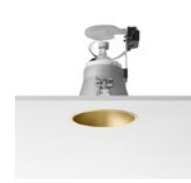

QR-CBC 51
GX5.3
MAX 50W

-OR-

LED
QR-CBC 51
GX5.3
7W

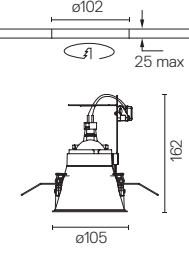

Empotrable para lámpara halógena de 12V. Transformador remoto no incluido. Marco de instalación no necesario.

12V halogen lamp recessed downlight. Remote transformer not included. Installation frame not necessary.

03.4450.B1A

03.4450.GLA

03.4450.BUA

03.4450.74A

03.4450.CUA

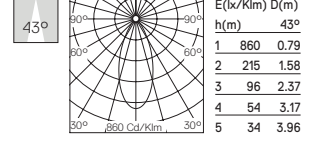
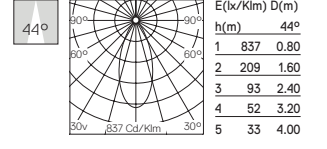
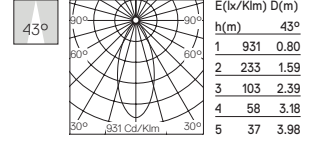
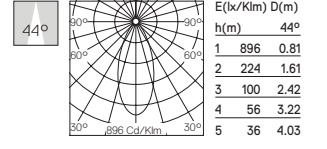

El ensayo de la curva fotométrica ha sido realizado para 50W con un ángulo de apertura de 38°.

Photometric data made with 50W - 38° lamp.

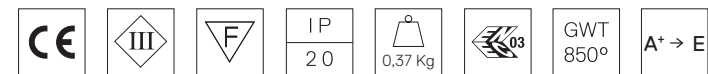
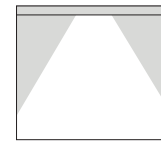

EASY KAP Ø105 FIXED

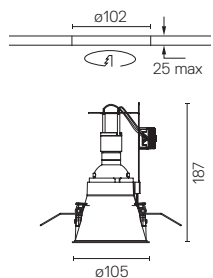
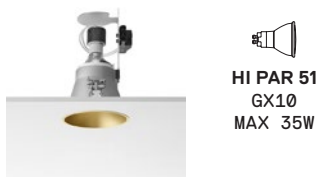

Empotrable para lámpara de halogenuro metálico. Balasto no incluido. Marco de instalación no necesario.

Metal halide lamp recessed downlight. Remote control gear not included. Installation frame not necessary.

03.4451.B1A

03.4451.GLA

03.4451.BUA

03.4451.74A

03.4451.CUA

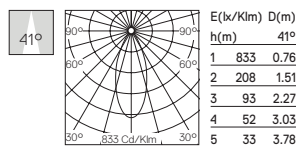
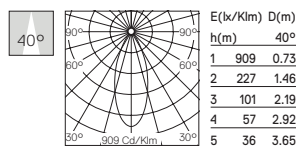
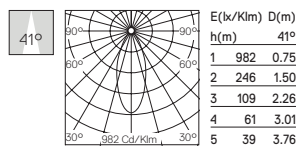
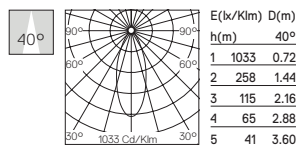

El ensayo de la curva fotométrica ha sido realizado para 35W con un ángulo de apertura de 25°.

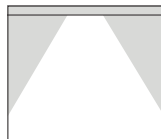

Photometric data made with 35W – 25° lamp.



EASY KAP Ø105 WALL-WASHER

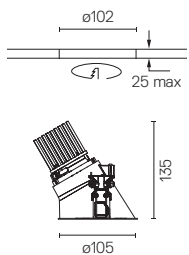

Empotrable para fuente de luz LED. Marco de instalación no necesario. Fuente de alimentación no incluida.

Embedded light fixture for LED light source. Mounting frame not required. Power supply not included.

2700K 03.4493.B1B

3000K 03.4463.B1B

2700K 03.4493.GLB

3000K 03.4463.GLB

2700K 03.4493.BUB

3000K 03.4463.BUB

2700K 03.4493.74B

3000K 03.4463.74B

2700K 03.4493.CUB

3000K 03.4463.CUB

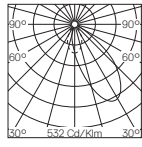
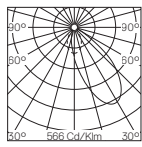
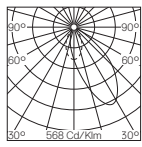
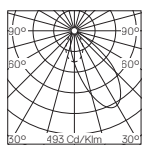

Equipos recomendados: Recommended power supply:

- Non Dimmable 60.8650
- Dimmable 1-10V 60.8533
- Dimmable Dali 60.8530
- Mains Dimming 60.8534

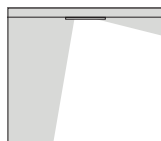

LED INCL. NOT REPLACEABLE

KAP

EASY KAP Ø105 WALL-WASHER



QR-CBC 51 GX5.3 MAX 50W

-OR-

LED QR-CBC 51 GX5.3 7W

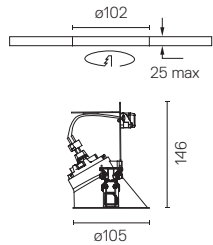

Empotrable para lámpara halógena de 12V. Transformador remoto no incluido. Marco de instalación no necesario.

12V halogen lamp recessed downlight. Remote transformer not included. Installation frame not necessary.

03.4455.B1A
03.4455.GLA
03.4455.BUA
03.4455.74A
03.4455.CUA

El ensayo de la curva fotométrica ha sido realizado para 50W con un ángulo de apertura de 38°.

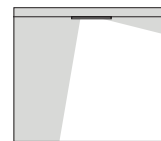

Photometric data made with 50W – 38° lamp.

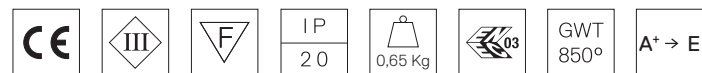

EASY KAP Ø105 WALL-WASHER

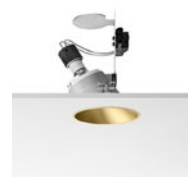

HI PAR 51 GX10 MAX 35W

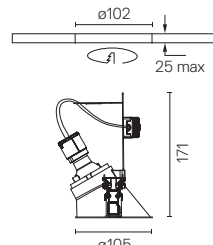

Empotrable para lámpara de halogenuro metálico. Balasto no incluido. Marco de instalación no necesario.

Metal halide lamp recessed downlight. Remote control gear not included. Installation frame not necessary.

03.4456.B1A
03.4456.GLA
03.4456.BUA
03.4456.74A
03.4456.CUA

El ensayo de la curva fotométrica ha sido realizado para 35W con un ángulo de apertura de 40°.

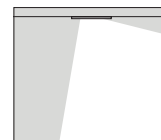

Photometric data made with 35W – 40° lamp.



Crerios: Número de luminarias n>5
Criteria: Number of luminaires n>5
Altura del techo 3 m
Heigh of the ceiling 3 m
Distancia a la pared (m)
Distance to the wall (m)
0,75 0,75 1,00 1,00

Interdistancia entre luminarias (m)
Distance between the luminaires (m)
0,75 1,00 1,00 1,25

Iluminancia QR-CBC 51 50W (lx)
Illuminance QR-CBC 51 50W (lx)
140 107 99 79

Crerios: Número de luminarias n>5
Criteria: Number of luminaires n>5
Altura del techo 3 m
Heigh of the ceiling 3 m
Distancia a la pared (m)
Distance to the wall (m)
0,75 0,75 1,00 1,00

Interdistancia entre luminarias (m)
Distance between the luminaires (m)
0,75 1,00 1,00 1,25

Iluminancia HI PAR 51 35W (lx)
Illuminance HI PAR 51 35W (lx)
312 240 220 177

KAP

KAP Ø80 FIXED



LED ARRAY
DC 500 mA
9,2W
698 lm
2700K/CRI 90

9,2W
810 lm
3000K/CRI 90

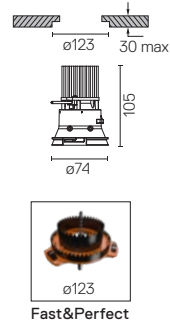

Empotrable para fuente de luz LED. Fuente de alimentación no incluida.

Embedded light fixture for LED light source. Power supply not included.

2700K
□ 03.4181.B1
3000K
□ 03.4180.B1

2700K
■ 03.4181.GL
3000K
■ 03.4180.GL

2700K
■ 03.4181.BU
3000K
■ 03.4180.BU

Lente difusora incluida.
Diffusing lens included.

Equipos recomendados:
Recommended power supply:

Non Dimmable 60.8880
Dimmable 1-10V 60.8533
Dimmable Dali 60.8530
Mains Dimming 60.8534

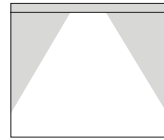

LED INCL.
NOT REPLACEABLE



2700K
■ 03.4181.CU
3000K
■ 03.4180.CU

KAP 80 SQUARE FIXED



LED ARRAY
DC 500 mA
9,2W
698 lm
2700K/CRI 90

9,2W
810 lm
3000K/CRI 90

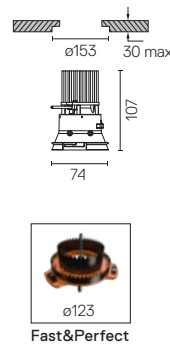

Empotrable para fuente de luz LED. Fuente de alimentación no incluida.

Embedded light fixture for LED light source. Power supply not included.

2700K
□ 03.4183.B1
3000K
□ 03.4182.B1

2700K
■ 03.4183.GL
3000K
■ 03.4182.GL

2700K
■ 03.4183.BU
3000K
■ 03.4182.BU

Lente difusora incluida.
Diffusing lens included.

Equipos recomendados:
Recommended power supply:

Non Dimmable 60.8880
Dimmable 1-10V 60.8533
Dimmable Dali 60.8530
Mains Dimming 60.8534

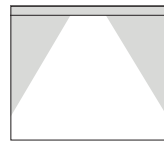

LED INCL.
NOT REPLACEABLE



2700K
■ 03.4183.CU
3000K
■ 03.4182.CU

Marco de pre-instalación Fast&Perfect. Se ha de pedir por separado.
Fast&Perfect pre-installation frame. To be ordered separately.

KAP

KAP Ø80 FIXED

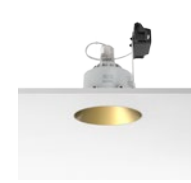

QR-CBC 51
GX5.3
MAX 50W

-OR-

LED
QR-CBC 51
GX5.3
MAX 8W

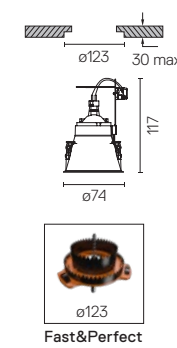

Empotrable para lámpara halógena de 12V. Transformador remoto no incluido.

12V halogen lamp recessed downlight. Remote transformer not included.

□ 03.4228.B1

■ 03.4228.GL

■ 03.4228.BU

■ 03.4228.74

■ 03.4228.CU

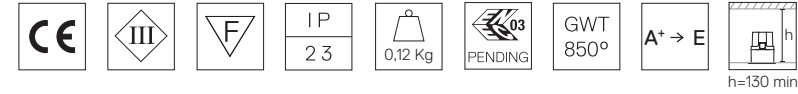

KAP 80 SQUARE FIXED



QR-CBC 51
GX5.3
MAX 50W

-OR-

LED
QR-CBC 51
GX5.3
MAX 8W

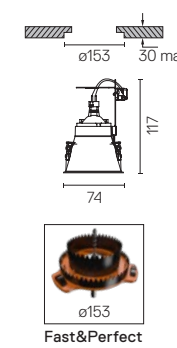

Empotrable para lámpara halógena de 12V. Transformador remoto no incluido.

12V halogen lamp recessed downlight. Remote transformer not included.

□ 03.4226.B1

■ 03.4226.GL

■ 03.4226.BU

■ 03.4226.74

■ 03.4226.CU

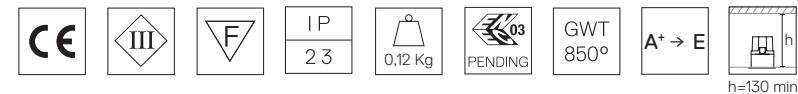

Marco de pre-instalación Fast&Perfect. Se ha de pedir por separado.
Fast&Perfect pre-installation frame. To be ordered separately.

KAP

KAP Ø80 FIXED

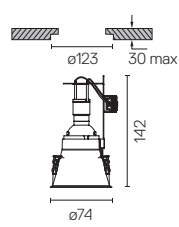

Empotrable con alimentación directa a red.
Recessed downlight with main voltage source.

03.4229.B1
03.4229.GL
03.4229.BU
03.4229.74
03.4229.CU

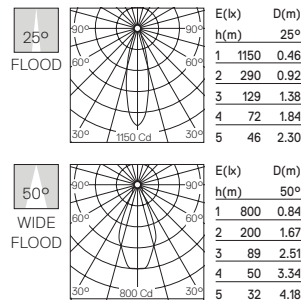
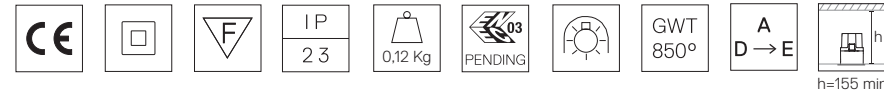
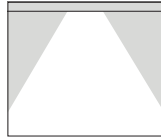

KAP Ø80 ADJUSTABLE

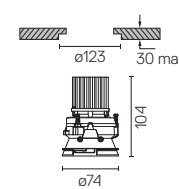
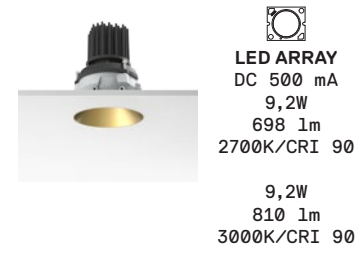

Empotrable para fuente de luz LED. Fuente de alimentación no incluida.
Embedded light fixture for LED light source. Power supply not included.

2700K
03.4185.B1
3000K
03.4184.B1



2700K
03.4185.GL
3000K
03.4184.GL

2700K
03.4185.BU
3000K
03.4184.BU

2700K
03.4185.74
3000K
03.4184.74

Lente difusora incluida.
Diffusing lens included.

Equipos recomendados:
Recommended power supply:

Non Dimmable 60.8880
Dimmable 1-10V 60.8533
Dimmable Dali 60.8530
Mains Dimming 60.8534

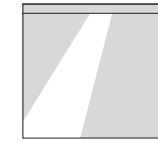

LED INCL.
NOT REPLACEABLE



2700K
03.4185.CU
3000K
03.4184.CU

KAP 80 SQUARE FIXED

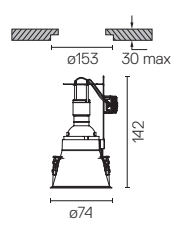
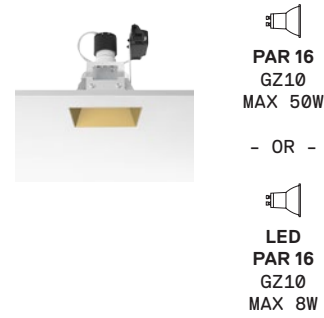

Empotrable con alimentación directa a red.
Recessed downlight with main voltage source.

03.4227.B1
03.4227.GL
03.4227.BU
03.4227.74
03.4227.CU

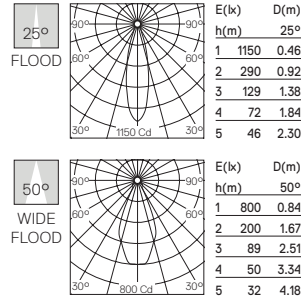
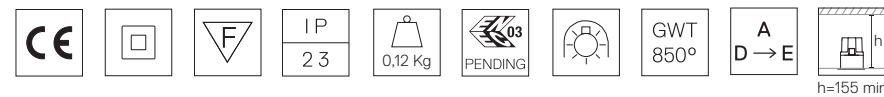
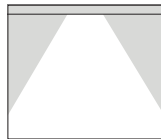

KAP 80 SQUARE ADJUSTABLE

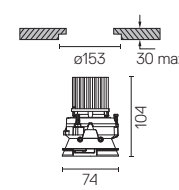
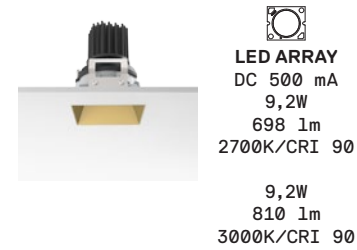

Empotrable para fuente de luz LED. Fuente de alimentación no incluida.
Embedded light fixture for LED light source. Power supply not included.

2700K
03.4187.B1
3000K
03.4186.B1



2700K
03.4187.GL
3000K
03.4186.GL

2700K
03.4187.BU
3000K
03.4186.BU

Lente difusora incluida.
Diffusing lens included.

Equipos recomendados:
Recommended power supply:

Non Dimmable 60.8880
Dimmable 1-10V 60.8533
Dimmable Dali 60.8530
Mains Dimming 60.8534

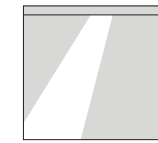

LED INCL.
NOT REPLACEABLE



2700K
03.4187.74
3000K
03.4186.74

2700K
03.4187.CU
3000K
03.4186.CU

Marco de pre-instalación Fast&Perfect. Se ha de pedir por separado.
Fast&Perfect pre-installation frame. To be ordered separately.

Marco de pre-instalación Fast&Perfect. Se ha de pedir por separado.
Fast&Perfect pre-installation frame. To be ordered separately.

KAP

KAP Ø80 ADJUSTABLE

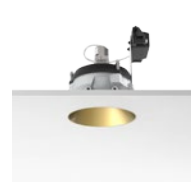

LED
QR-CBC 51
GX5.3
MAX 8W

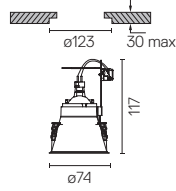

Empotrable para lámpara halógena de 12V. Transformador remoto no incluido.

12V halogen lamp recessed downlight. Remote transformer not included.



Fast&Perfect

03.4236.B1

03.4236.GL

03.4236.BU

03.4236.74

03.4236.CU

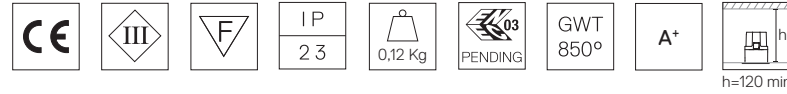

KAP 80 SQUARE ADJUSTABLE



LED
QR-CBC 51
GX5.3
MAX 8W

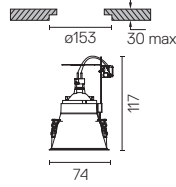

Empotrable para lámpara halógena de 12V. Transformador remoto no incluido.

12V halogen lamp recessed downlight. Remote transformer not included.



Fast&Perfect

03.4234.B1

03.4234.GL

03.4234.BU

03.4234.74

03.4234.CU

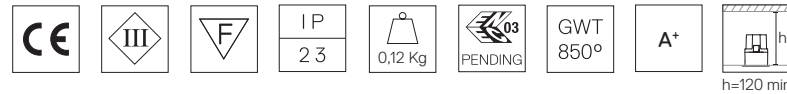

Marco de pre-instalación Fast&Perfect. Se ha de pedir por separado.
Fast&Perfect pre-installation frame. To be ordered separately.

KAP

KAP Ø80 ADJUSTABLE

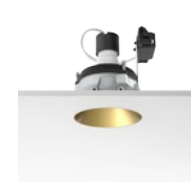

LED
PAR 16
GZ10
MAX 8W

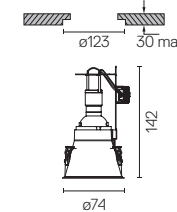

Empotrable con alimentación directa a red.
Recessed downlight with main voltage source.

03.4237.B1
03.4237.GL
03.4237.BU
03.4237.74
03.4237.CU



Fast&Perfect

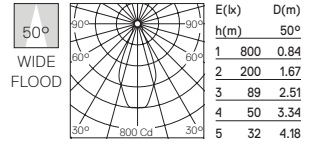
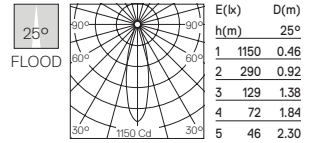
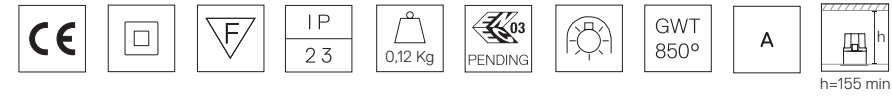
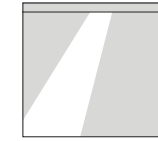

KAP 80 SQUARE ADJUSTABLE



LED
PAR 16
GZ10
MAX 8W

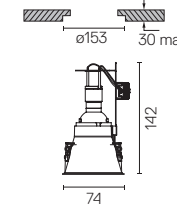

Empotrable con alimentación directa a red.
Recessed downlight with main voltage source.

03.4235.B1
03.4235.GL
03.4235.BU
03.4235.74
03.4235.CU



Fast&Perfect

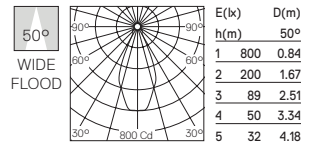
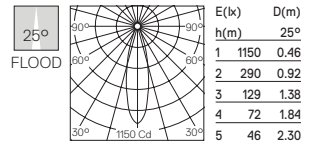
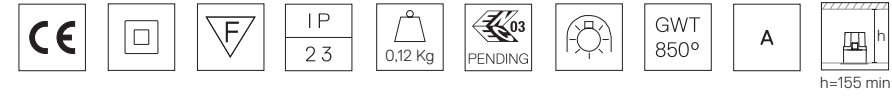
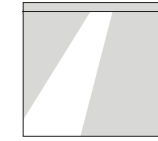

Marco de pre-instalación Fast&Perfect. Se ha de pedir por separado.
Fast&Perfect pre-installation frame. To be ordered separately.

KAP

KAP Ø80 WALL-WASHER

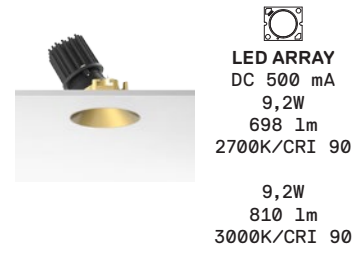

LED ARRAY
DC 500 mA
9,2W
698 lm
2700K/CRI 90

9,2W
810 lm
3000K/CRI 90

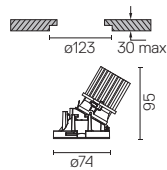

Fast&Perfect

Empotrable para fuente de luz LED. Fuente de alimentación no incluida.

Embedded light fixture for LED light source. Power supply not included.

2700K
03.4189.B1
3000K
03.4188.B1

2700K
03.4189.GL
3000K
03.4188.GL

2700K
03.4189.BU
3000K
03.4188.BU

Lente difusora incluida.
Diffusing lens included.

Equipos recomendados:
Recommended power supply:

Non Dimmable 60.8880
Dimmable 1-10V 60.8533
Dimmable Dali 60.8530
Mains Dimming 60.8534

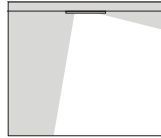

LED INCL.
NOT REPLACEABLE



2700K
03.4189.74
3000K
03.4188.74

2700K
03.4189.CU
3000K
03.4188.CU

KAP 80 SQUARE WALL-WASHER

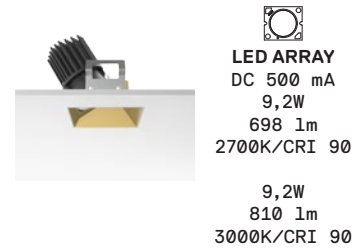

LED ARRAY
DC 500 mA
9,2W
698 lm
2700K/CRI 90

9,2W
810 lm
3000K/CRI 90

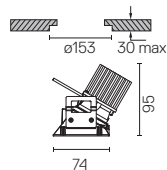

Fast&Perfect

Empotrable para fuente de luz LED. Fuente de alimentación no incluida.

Embedded light fixture for LED light source. Power supply not included.

2700K
03.4191.B1
3000K
03.4190.B1

2700K
03.4191.GL
3000K
03.4190.GL

2700K
03.4191.BU
3000K
03.4190.BU

Lente difusora incluida.
Diffusing lens included.

Equipos recomendados:
Recommended power supply:

Non Dimmable 60.8880
Dimmable 1-10V 60.8533
Dimmable Dali 60.8530
Mains Dimming 60.8534

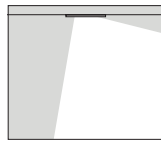

LED INCL.
NOT REPLACEABLE



2700K
03.4191.74
3000K
03.4190.74

2700K
03.4191.CU
3000K
03.4190.CU

Marco de pre-instalación Fast&Perfect. Se ha de pedir por separado.
Fast&Perfect pre-installation frame. To be ordered separately.

KAP

KAP Ø80 WALL-WASHER



QR-CBC 51
GX5.3
MAX 50W

-OR-

LED
QR-CBC 51
GX5.3
MAX 8W

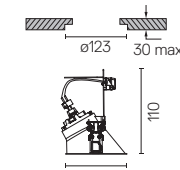

Fast&Perfect

Empotrable para lámpara halógena de 12V. Transformador remoto no incluido.

12V halogen lamp recessed downlight. Remote transformer not included.

03.4244.B1

03.4244.GL

03.4244.BU

03.4244.74

03.4244.CU



KAP 80 SQUARE WALL-WASHER



QR-CBC 51
GX5.3
MAX 50W

-OR-

LED
QR-CBC 51
GX5.3
MAX 8W

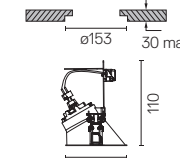

Fast&Perfect

Empotrable para lámpara halógena de 12V. Transformador remoto no incluido.

12V halogen lamp recessed downlight. Remote transformer not included.

03.4242.B1

03.4242.GL

03.4242.BU

03.4242.74

03.4242.CU

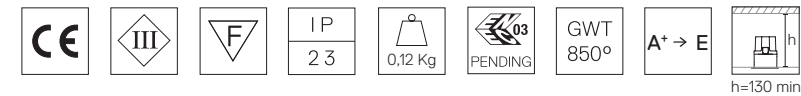

Marco de pre-instalación Fast&Perfect. Se ha de pedir por separado.
Fast&Perfect pre-installation frame. To be ordered separately.

KAP Ø80 WALL-WASHER

PAR 16
GZ10
MAX 50W

- OR -

LED
PAR 16
GZ10
MAX 8W

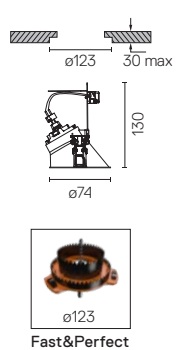

Empotrable con alimentación directa a red.
Recessed downlight with main voltage source.

- 03.4245.B1
- 03.4245.GL
- 03.4245.BU
- 03.4245.74
- 03.4245.CU



CE, Square, F, IP 23, 0,12 Kg, PENDING, GWT 850°, A D → E, h=140 min

KAP 80 SQUARE WALL-WASHER

PAR 16
GZ10
MAX 50W

- OR -

LED
PAR 16
GZ10
MAX 8W

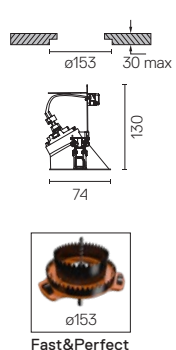

Empotrable con alimentación directa a red.
Recessed downlight with main voltage source.

- 03.4243.B1
- 03.4243.GL
- 03.4243.BU
- 03.4243.74
- 03.4243.CU

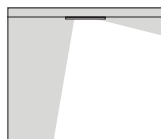

CE, Square, F, IP 23, 0,12 Kg, PENDING, GWT 850°, A D → E, h=140 min

Marco de pre-instalación Fast&Perfect. Se ha de pedir por separado.
Fast&Perfect pre-installation frame. To be ordered separately.

KAP Ø105

PHOSPHOR
LED
15,6W
1300 lm
2700K/CRI 98

11,7W
1300 lm
3000K/CRI 80

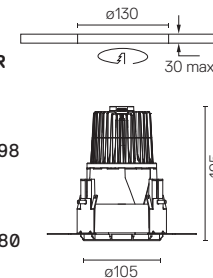

Empotrable para LED.
Transformador electrónico
220/240V remoto incluido.

LED recessed downlight.
Remote electronic
transformer 220/240V
included.

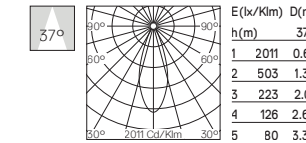
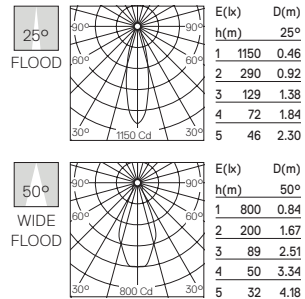

Marco de pre-instalación conveccional y/o Fast&Perfect. Se ha de pedir por separado.
Conventional pre-installation frame and/or Fast&Perfect. To be ordered separately.

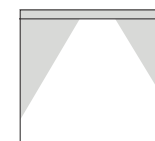

CE, Square, F, IP 44, 0,83 Kg, PENDING, GWT 850°

LED INCL.
NOT REPLACEABLE

- 2700K
- Non Dimmable
 - 03.4494.B1B
 - Dali Version
 - 03.4494.B1BDA
 - 1-10V
 - 03.4494.B1B1V
- 3000K
- Non Dimmable
 - 03.4407.B1B
 - Dali Version
 - 03.4407.B1BDA
 - 1-10V
 - 03.4407.B1B1V

- 2700K
- Non Dimmable
 - 03.4494.GLB
 - Dali Version
 - 03.4494.GLBDA
 - 1-10V
 - 03.4494.GLB1V
- 3000K
- Non Dimmable
 - 03.4407.GLB
 - Dali Version
 - 03.4407.GLBDA
 - 1-10V
 - 03.4407.GLB1V

- 2700K
- Non Dimmable
 - 03.4494.BUB
 - Dali Version
 - 03.4494.BUBDA
 - 1-10V
 - 03.4494.BUB1V
- 3000K
- Non Dimmable
 - 03.4407.BUB
 - Dali Version
 - 03.4407.BUBDA
 - 1-10V
 - 03.4407.BUB1V

- 2700K
- Non Dimmable
 - 03.4494.74B
 - Dali Version
 - 03.4494.74BDA
 - 1-10V
 - 03.4494.74B1V
- 3000K
- Non Dimmable
 - 03.4407.74B
 - Dali Version
 - 03.4407.74BDA
 - 1-10V
 - 03.4407.74B1V

- 2700K
- Non Dimmable
 - 03.4494.CUB
 - Dali Version
 - 03.4494.CUBDA
 - 1-10V
 - 03.4494.CUB1V
- 3000K
- Non Dimmable
 - 03.4407.CUB
 - Dali Version
 - 03.4407.CUBDA
 - 1-10V
 - 03.4407.CUB1V

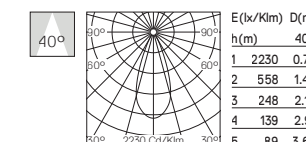
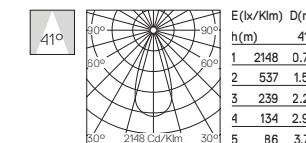
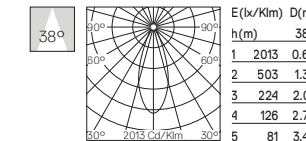

KAP 105 SQUARE

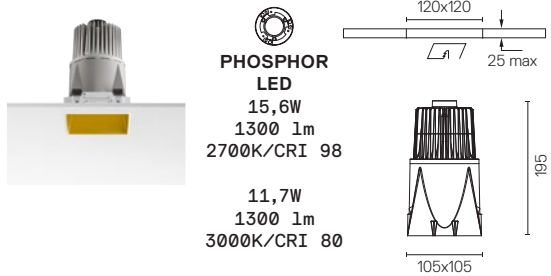

KAP

Empotrable para LED.
Transformador electrónico
220/240V remoto
incluido.

LED recessed downlight.
Remote electronic
transformer 220/240V
included.

- 2700K
Non Dimmable
 03.4595.B1B
Dali Version
 03.4595.B1BDA
1-10V
 03.4595.B1B1V

- 3000K
Non Dimmable
 03.4570.B1B
Dali Version
 03.4570.B1BDA
1-10V
 03.4570.B1B1V

- 2700K
Non Dimmable
 03.4595.GLB
Dali Version
 03.4595.GLBDA
1-10V
 03.4595.GLB1V

- 3000K
Non Dimmable
 03.4570.GLB
Dali Version
 03.4570.GLBDA
1-10V
 03.4570.GLB1V

- 2700K
Non Dimmable
 03.4595.BUB
Dali Version
 03.4595.BUBDA
1-10V
 03.4595.BUB1V

- 3000K
Non Dimmable
 03.4570.BUB
Dali Version
 03.4570.BUBDA
1-10V
 03.4570.BUB1V

- 2700K
Non Dimmable
 03.4595.74B
Dali Version
 03.4595.74BDA
1-10V
 03.4595.74B1V

- 3000K
Non Dimmable
 03.4570.74B
Dali Version
 03.4570.74BDA
1-10V
 03.4570.74B1V

- 2700K
Non Dimmable
 03.4595.CUB
Dali Version
 03.4595.CUBDA
1-10V
 03.4595.CUB1V

- 3000K
Non Dimmable
 03.4570.CUB
Dali Version
 03.4570.CUBDA
1-10V
 03.4570.CUB1V

Marco de pre-instalación. Se ha de pedir por separado.

Pre-installation frame. To be ordered separately.

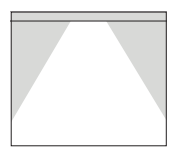

LED INCL.
NOT REPLACEABLE

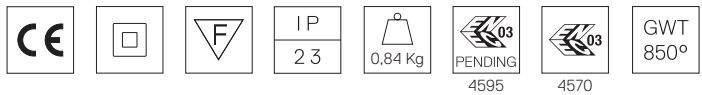

KAP Ø105

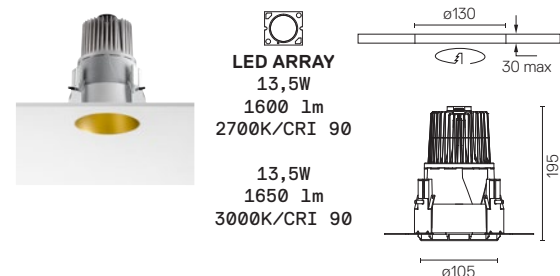

Empotrable para LED.
Transformador electrónico
220/240V remoto incluido.

LED recessed downlight.
Remote electronic
transformer 220/240V
included.

- LED ARRAY
13,5W
1600 lm
2700K/CRI 90

13,5W
1650 lm
3000K/CRI 90

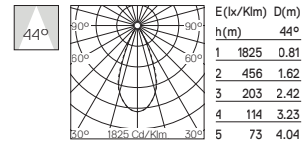
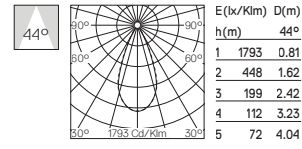
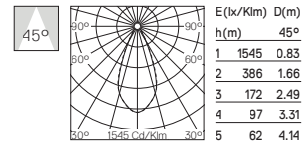
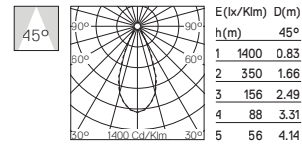

- 2700K
Non Dimmable
 03.4581.B1
Dali Version
 03.4581.B1.DA
1-10V
 03.4581.B1.1V

- 3000K
Non Dimmable
 03.4580.B1
Dali Version
 03.4580.B1.DA
1-10V
 03.4580.B1.1V

- 2700K
Non Dimmable
 03.4581.GL
Dali Version
 03.4581.GL.DA
1-10V
 03.4581.GL.1V

- 3000K
Non Dimmable
 03.4580.GL
Dali Version
 03.4580.GL.DA
1-10V
 03.4580.GL.1V

- 2700K
Non Dimmable
 03.4581.BU
Dali Version
 03.4581.BU.DA
1-10V
 03.4581.BU.1V

- 3000K
Non Dimmable
 03.4580.BU
Dali Version
 03.4580.BU.DA
1-10V
 03.4580.BU.1V

- 2700K
Non Dimmable
 03.4581.74
Dali Version
 03.4581.74.DA
1-10V
 03.4581.74.1V

- 3000K
Non Dimmable
 03.4580.74
Dali Version
 03.4580.74.DA
1-10V
 03.4580.74.1V

- 2700K
Non Dimmable
 03.4581.CU
Dali Version
 03.4581.CU.DA
1-10V
 03.4581.CU.1V

- 3000K
Non Dimmable
 03.4580.CU
Dali Version
 03.4580.CU.DA
1-10V
 03.4580.CU.1V

Marco de pre-instalación conveccional
y/o Fast&Perfect. Se ha de pedir por
separado.

Conventional pre-installation frame
and/or Fast&Perfect. To be ordered
separately.

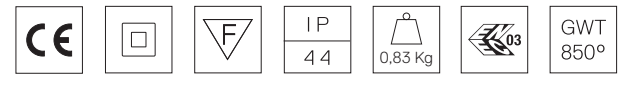
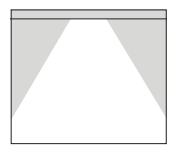

LED INCL.
NOT REPLACEABLE

KAP

KAP 105 SQUARE

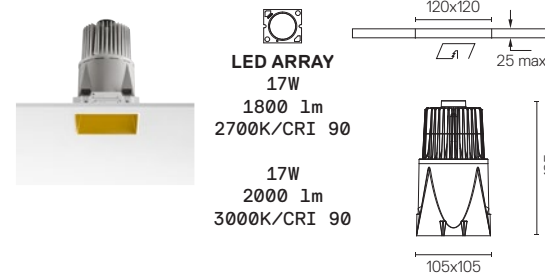

Empotrable para LED.
Transformador electrónico
220/240V remoto
incluido.

LED recessed downlight.
Remote electronic
transformer 220/240V
included.

- 2700K
Non Dimmable
03.4583.B1
Dali Version
03.4583.B1.DA
1-10V
03.4583.B1.1V

- 3000K
Non Dimmable
03.4582.B1
Dali Version
03.4582.B1.DA
1-10V
03.4582.B1.1V

- 2700K
Non Dimmable
03.4583.GL
Dali Version
03.4583.GL.DA
1-10V
03.4583.GL.1V

- 3000K
Non Dimmable
03.4582.GL
Dali Version
03.4582.GL.DA
1-10V
03.4582.GL.1V

- 2700K
Non Dimmable
03.4583.BU
Dali Version
03.4583.BU.DA
1-10V
03.4583.BU.1V

- 3000K
Non Dimmable
03.4582.BU
Dali Version
03.4582.BU.DA
1-10V
03.4582.BU.1V

- 2700K
Non Dimmable
03.4583.74
Dali Version
03.4583.74.DA
1-10V
03.4583.74.1V

- 3000K
Non Dimmable
03.4582.74
Dali Version
03.4582.74.DA
1-10V
03.4582.74.1V

- 2700K
Non Dimmable
03.4583.CU
Dali Version
03.4583.CU.DA
1-10V
03.4583.CU.1V

- 3000K
Non Dimmable
03.4582.CU
Dali Version
03.4582.CU.DA
1-10V
03.4582.CU.1V

Marco de pre-instalación. Se ha de pedir por separado.

Pre-installation frame. To be ordered separately.

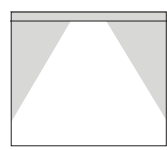

LED INCL.
NOT REPLACEABLE

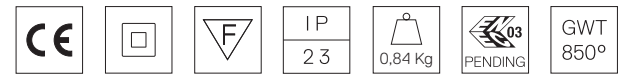

KAP

KAP Ø105

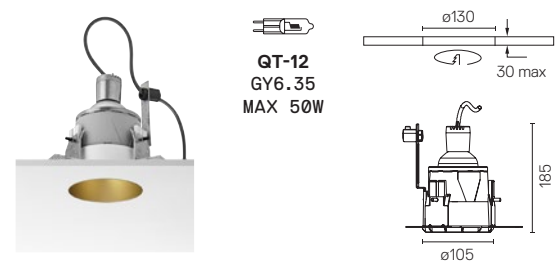

Empotrable para lámpara
halógena de 12V.
Transformador remoto no
incluido.

12V halogen lamp
recessed downlight.
Remote transformer not
included.

- 03.4400.B1

- 03.4400.GL

- 03.4400.BU

- 03.4400.74

- 03.4400.CU

Marco de pre-instalación conveccional
y/o Fast&Perfect. Se ha de pedir por
separado.

Conventional pre-installation frame
and/or Fast&Perfect. To be ordered
separately.

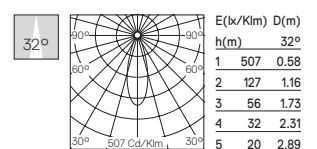
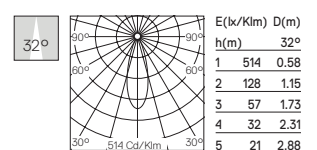
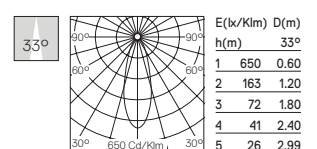
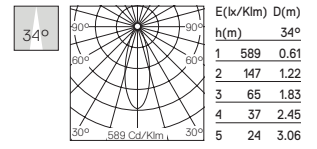
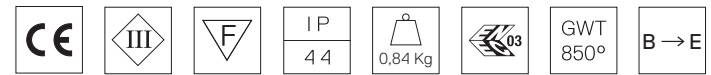
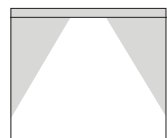

KAP 105 SQUARE

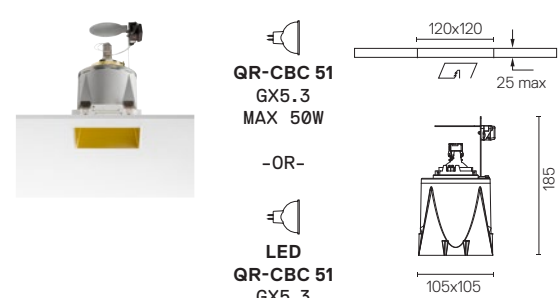

Empotrable para lámpara
halógena de 12V.
Transformador remoto no
incluido.

12V halogen lamp
recessed downlight.
Remote transformer not
included.

- 03.4572.B1

- 03.4572.GL

- 03.4572.BU

- 03.4572.74

- 03.4572.CU

Marco de pre-instalación. Se ha de
pedir por separado.

Pre-installation frame. To be ordered
separately.

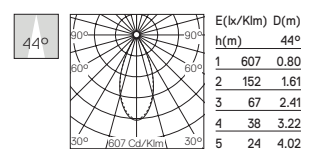
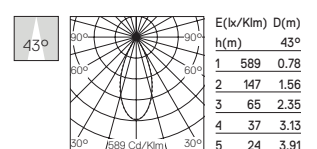
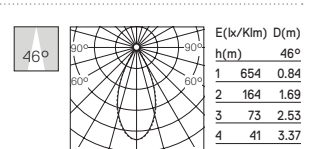
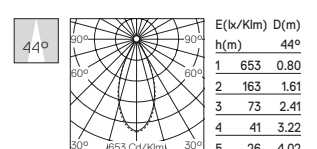
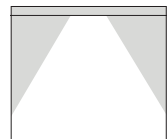

180.0 ——— 0.0
270.0 - - - - - 90.0

KAP Ø105



CDM-TC
G8.5
MAX 35W

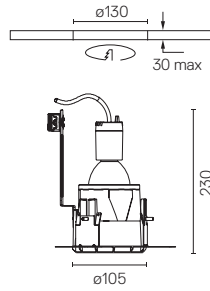

Empotrable para lámpara de halogenuro metálico. Balasto no incluido.

Metal halide lamp recessed downlight. Remote control gear not included.

03.4401.B1

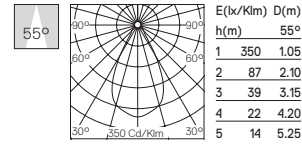

03.4401.GL

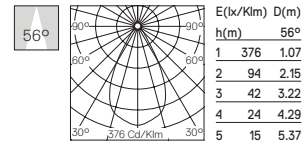

03.4401.BU

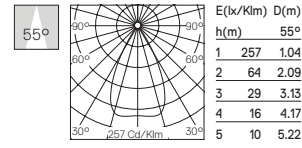

03.4401.74

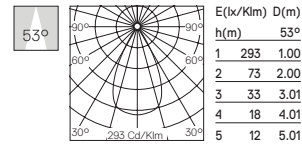

03.4401.CU

Marco de pre-instalación conveccional y/o Fast&Perfect. Se ha de pedir por separado.

Conventional pre-installation frame and/or Fast&Perfect. To be ordered separately.

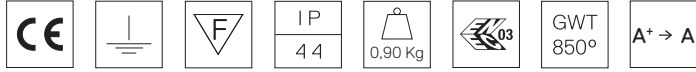
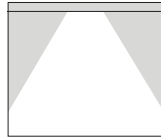

KAP 105 SQUARE



HI PAR 51
GX10
MAX 35W

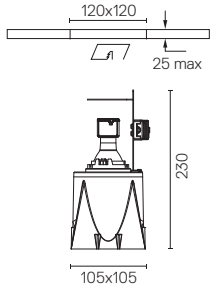

Empotrable para lámpara de halogenuro metálico. Balasto no incluido.

Metal halide lamp recessed downlight. Remote control gear not included.

03.4571.B1

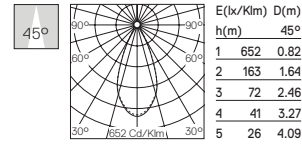

03.4571.GL

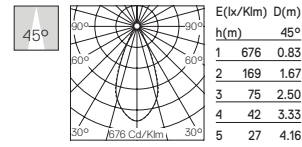

03.4571.BU

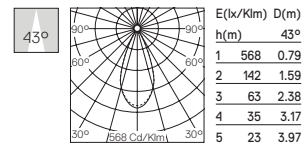

03.4571.74

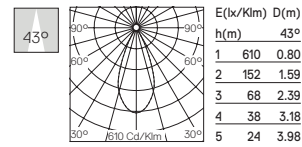

03.4571.CU

Marco de pre-instalación. Se ha de pedir por separado.

Pre-installation frame. To be ordered separately.

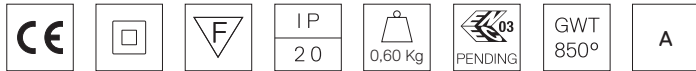
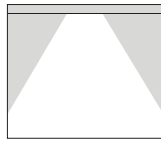

KAP Ø145



PHOSPHOR
LED
17W
1400 lm
2700K/CRI 98

19,5W
2000 lm
3000K/CRI 80

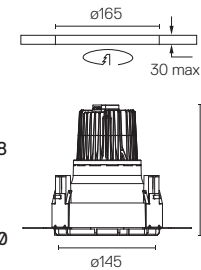

Empotrable para LED. Transformador electrónico 220/240V remoto incluido.

LED recessed downlight. Remote electronic transformer 220/240V included.

2700K
Non Dimmable
03.4496.B1B
Dali Version
03.4496.B1BDA
1-10V
03.4496.B1B1V

3000K
Non Dimmable
03.4420.B1B
Dali Version
03.4420.B1BDA
1-10V
03.4420.B1B1V

2700K
Non Dimmable
03.4496.GLB
Dali Version
03.4496.GLBDA
1-10V
03.4496.GLB1V

3000K
Non Dimmable
03.4420.GLB
Dali Version
03.4420.GLBDA
1-10V
03.4420.GLB1V

2700K
Non Dimmable
03.4496.BUB
Dali Version
03.4496.BUBDA
1-10V
03.4496.BUB1V

3000K
Non Dimmable
03.4420.BUB
Dali Version
03.4420.BUBDA
1-10V
03.4420.BUB1V

2700K
Non Dimmable
03.4496.74B
Dali Version
03.4496.74BDA
1-10V
03.4496.74B1V

3000K
Non Dimmable
03.4420.74B
Dali Version
03.4420.74BDA
1-10V
03.4420.74B1V

2700K
Non Dimmable
03.4496.CUB
Dali Version
03.4496.CUBDA
1-10V
03.4496.CUB1V

3000K
Non Dimmable
03.4420.CUB
Dali Version
03.4420.CUBDA
1-10V
03.4420.CUB1V

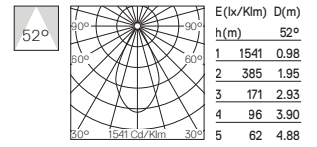
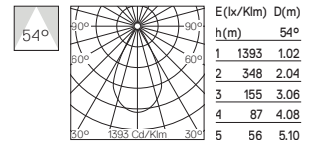
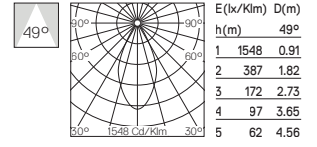
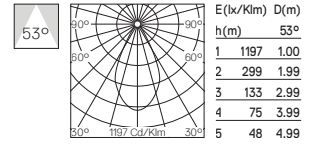

Marco de pre-instalación. Se ha de pedir por separado.

Pre-installation frame. To be ordered separately.

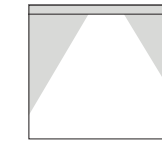

LED INCL.
NOT REPLACEABLE

KAP Ø145



LED ARRAY
17W
1800 lm
2700K/CRI 90

17W
2000 lm
3000K/CRI 90

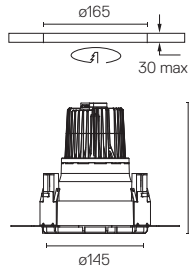

Empotrable para LED.
Transformador electrónico
220/240V remoto incluido.

LED recessed downlight.
Remote electronic
transformer 220/240V
included.

- 2700K
Non Dimmable
 03.4585.B1
Dali Version
 03.4585.B1.DA
1-10V
 03.4585.B1.1V

- 3000K
Non Dimmable
 03.4584.B1
Dali Version
 03.4584.B1.DA
1-10V
 03.4584.B1.1V

- 2700K
Non Dimmable
 03.4585.GL
Dali Version
 03.4585.GL.DA
1-10V
 03.4585.GL.1V

- 3000K
Non Dimmable
 03.4584.GL
Dali Version
 03.4584.GL.DA
1-10V
 03.4584.GL.1V

- 2700K
Non Dimmable
 03.4585.BU
Dali Version
 03.4585.BU.DA
1-10V
 03.4585.BU.1V

- 3000K
Non Dimmable
 03.4584.BU
Dali Version
 03.4584.BU.DA
1-10V
 03.4584.BU.1V

- 2700K
Non Dimmable
 03.4585.74
Dali Version
 03.4585.74.DA
1-10V
 03.4585.74.1V

- 3000K
Non Dimmable
 03.4584.74
Dali Version
 03.4584.74.DA
1-10V
 03.4584.74.1V

- 2700K
Non Dimmable
 03.4585.CU
Dali Version
 03.4585.CU.DA
1-10V
 03.4585.CU.1V

- 3000K
Non Dimmable
 03.4584.CU
Dali Version
 03.4584.CU.DA
1-10V
 03.4584.CU.1V

Marco de pre-instalación. Se ha de pedir por separado.

Pre-installation frame. To be ordered separately.

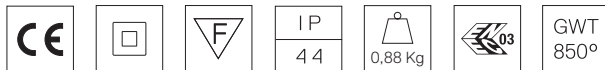
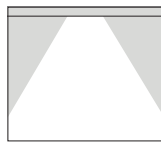

LED INCL.
NOT REPLACEABLE

KAP

KAP Ø145



QT-12
GY6.35
MAX 65W IRC

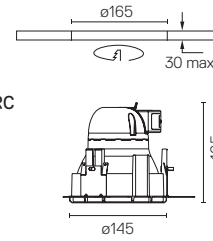

Empotrable para lámpara
halógena de 12V.
Transformador remoto no
incluido.

12V halogen lamp
recessed downlight.
Remote transformer not
included.

- 03.4491.B1
- 03.4491.GL
- 03.4491.BU
- 03.4491.74
- 03.4491.CU

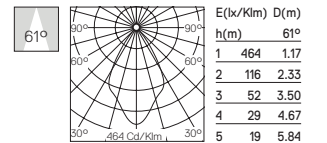
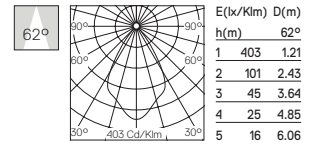
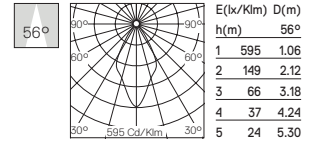
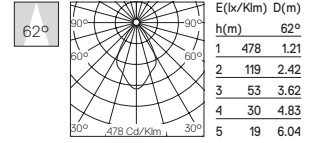

Marco de pre-instalación. Se ha de pedir por separado.

Pre-installation frame. To be ordered separately.

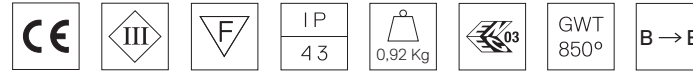
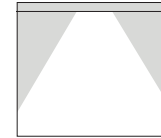

KAP Ø145



CDM-TC
G8.5
MAX 70W

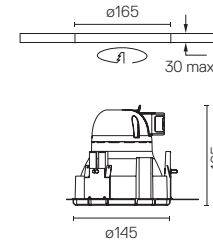

Empotrable para lámpara
de halogenuro metálico.
Balasto no incluido.

Metal halide lamp
recessed downlight.
Remote control gear not
included.

- 03.4490.B1
- 03.4490.GL
- 03.4490.BU
- 03.4490.74
- 03.4490.CU

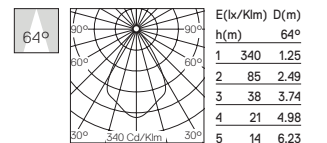
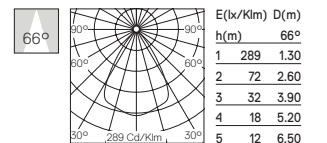
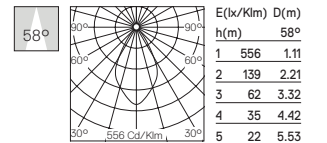
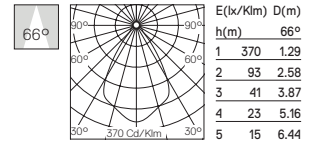

Marco de pre-instalación. Se ha de pedir por separado.

Pre-installation frame. To be ordered separately.

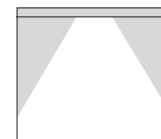

KAP

KAP Ø145 DEEP



PHOSPHOR LED
17W
1400 lm
2700K/CRI 98

19,5W
2000 lm
3000K/CRI 80

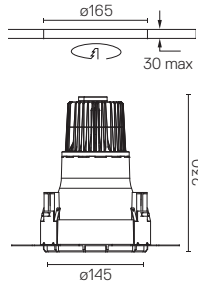

Empotrable para LED.
Transformador electrónico
220/240V remoto incluido.

LED recessed downlight.
Remote electronic
transformer 220/240V
included.

- 2700K
Non Dimmable
 03.4497.B1B
Dali Version
 03.4497.B1BDA
1-10V
 03.4497.B1B1V
- 3000K
Non Dimmable
 03.4482.B1B
Dali Version
 03.4482.B1BDA
1-10V
 03.4482.B1B1V

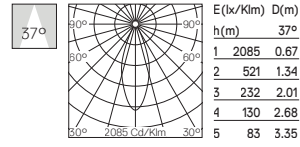

- 2700K
Non Dimmable
 03.4497.GLB
Dali Version
 03.4497.GLBDA
1-10V
 03.4497.GLB1V

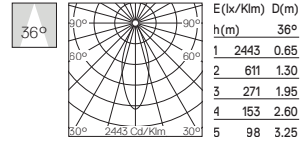

- 3000K
Non Dimmable
 03.4482.GLB
Dali Version
 03.4482.GLBDA
1-10V
 03.4482.GLB1V

- 2700K
Non Dimmable
 03.4497.BUB
Dali Version
 03.4497.BUBDA
1-10V
 03.4497.BUB1V

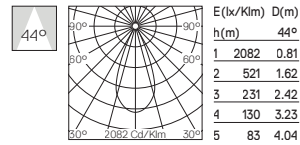

- 3000K
Non Dimmable
 03.4482.BUB
Dali Version
 03.4482.BUBDA
1-10V
 03.4482.BUB1V

- 2700K
Non Dimmable
 03.4497.74B
Dali Version
 03.4497.74BDA
1-10V
 03.4497.74B1V

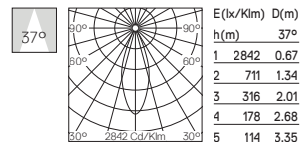

- 3000K
Non Dimmable
 03.4482.74B
Dali Version
 03.4482.74BDA
1-10V
 03.4482.74B1V

- 2700K
Non Dimmable
 03.4497.CUB
Dali Version
 03.4497.CUBDA
1-10V
 03.4497.CUB1V

- 3000K
Non Dimmable
 03.4482.CUB
Dali Version
 03.4482.CUBDA
1-10V
 03.4482.CUB1V

Marco de pre-instalación. Se ha de pedir por separado.

Pre-installation frame. To be ordered separately.

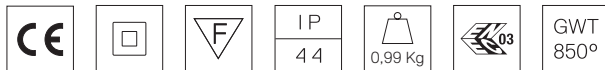
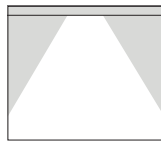

LED INCL.
NOT REPLACEABLE

164

KAP Ø145 DEEP



LED ARRAY
17W
1800 lm
2700K/CRI 90

17W
2000 lm
3000K/CRI 90

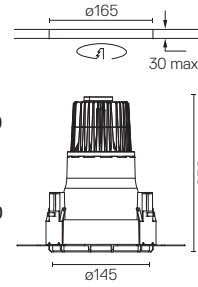

Empotrable para LED.
Transformador electrónico
220/240V remoto incluido.

LED recessed downlight.
Remote electronic
transformer 220/240V
included.

- 2700K
Non Dimmable
 03.4587.B1
Dali Version
 03.4587.B1.DA
1-10V
 03.4587.B1.1V
- 3000K
Non Dimmable
 03.4586.B1
Dali Version
 03.4586.B1.DA
1-10V
 03.4586.B1.1V

- 2700K
Non Dimmable
 03.4587.GL
Dali Version
 03.4587.GL.DA
1-10V
 03.4587.GL.1V

- 3000K
Non Dimmable
 03.4586.GL
Dali Version
 03.4586.GL.DA
1-10V
 03.4586.GL.1V

- 2700K
Non Dimmable
 03.4587.BU
Dali Version
 03.4587.BU.DA
1-10V
 03.4587.BU.1V

- 3000K
Non Dimmable
 03.4586.BU
Dali Version
 03.4586.BU.DA
1-10V
 03.4586.BU.1V

- 2700K
Non Dimmable
 03.4587.74
Dali Version
 03.4587.74.DA
1-10V
 03.4587.74.1V

- 3000K
Non Dimmable
 03.4586.74
Dali Version
 03.4586.74.DA
1-10V
 03.4586.74.1V

- 2700K
Non Dimmable
 03.4587.CU
Dali Version
 03.4587.CU.DA
1-10V
 03.4587.CU.1V

- 3000K
Non Dimmable
 03.4586.CU
Dali Version
 03.4586.CU.DA
1-10V
 03.4586.CU.1V

Marco de pre-instalación. Se ha de pedir por separado.

Pre-installation frame. To be ordered separately.

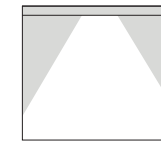

LED INCL.
NOT REPLACEABLE

165

KAP Ø145 DEEP



QT-12
GY6.35
MAX 65W IRC

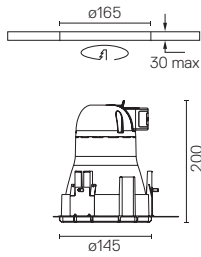

Empotrable para lámpara halógena de 12V. Transformador remoto no incluido.

12V halogen lamp recessed downlight. Remote transformer not included.

03.4481.B1

03.4481.GL

03.4481.BU

03.4481.74

03.4481.CU

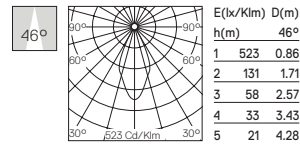
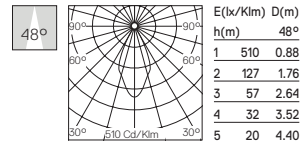
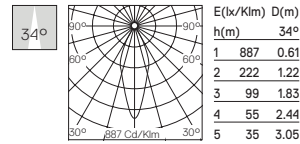
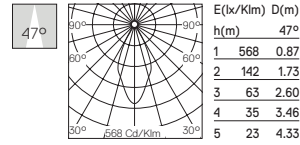

Marco de pre-instalación. Se ha de pedir por separado.

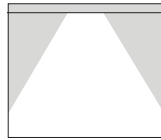

Pre-installation frame. To be ordered separately.

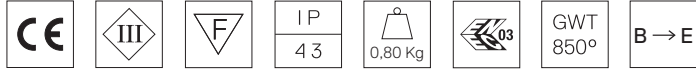

KAP Ø145 DEEP



CDM-TC
G8.5
MAX 70W

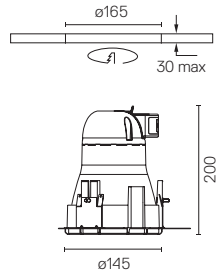

Empotrable para lámpara de halogenuro metálico. Balasto no incluido.

Metal halide lamp recessed downlight. Remote control gear not included.

03.4480.B1

03.4480.GL

03.4480.BU

03.4480.74

03.4480.CU

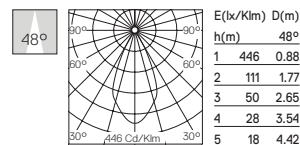
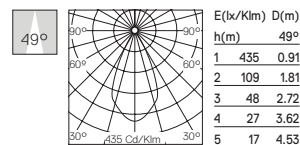
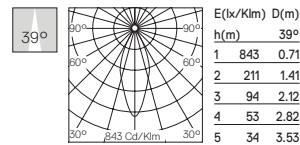
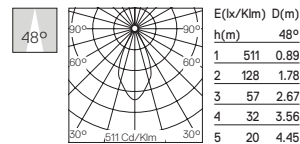

Marco de pre-instalación. Se ha de pedir por separado.

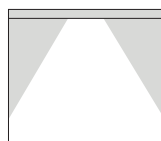

Pre-installation frame. To be ordered separately.



KAP Ø145 WALL-WASHER



PHOSPHOR
LED
17W
1400 lm
2700K/CRI 98

19,5W
2000 lm
3000K/CRI 80

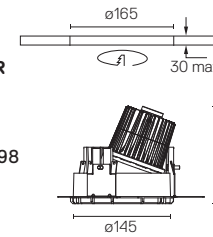

Empotrable para LED. Transformador electrónico 220/240V remoto incluido.

LED recessed downlight. Remote electronic transformer 220/240V included.

2700K
Non Dimmable
03.4498.B1B
Dali Version
03.4498.B1BDA
1-10V
03.4498.B1B1V

3000K
Non Dimmable
03.4475.B1B
Dali Version
03.4475.B1BDA
1-10V
03.4475.B1B1V

2700K
Non Dimmable
03.4498.GLB
Dali Version
03.4498.GLBDA
1-10V
03.4498.GLB1V

3000K
Non Dimmable
03.4475.GLB
Dali Version
03.4475.GLBDA
1-10V
03.4475.GLB1V

2700K
Non Dimmable
03.4498.BUB
Dali Version
03.4498.BUBDA
1-10V
03.4498.BUB1V

3000K
Non Dimmable
03.4475.BUB
Dali Version
03.4475.BUBDA
1-10V
03.4475.BUB1V

2700K
Non Dimmable
03.4498.74B
Dali Version
03.4498.74BDA
1-10V
03.4498.74B1V

3000K
Non Dimmable
03.4475.74B
Dali Version
03.4475.74BDA
1-10V
03.4475.74B1V

2700K
Non Dimmable
03.4498.CUB
Dali Version
03.4498.CUBDA
1-10V
03.4498.CUB1V

3000K
Non Dimmable
03.4475.CUB
Dali Version
03.4475.CUBDA
1-10V
03.4475.CUB1V

Marco de pre-instalación. Se ha de pedir por separado.

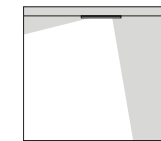

Pre-installation frame. To be ordered separately.

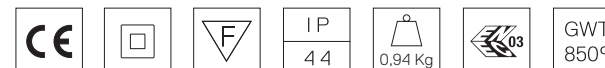

LED INCL.
NOT REPLACEABLE

KAP Ø145 WALL-WASHER

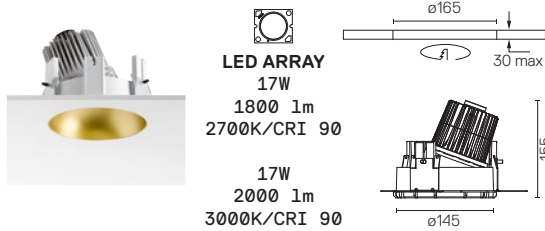

LED ARRAY
17W
1800 lm
2700K/CRI 90

17W
2000 lm
3000K/CRI 90

Empotrable para LED.
Transformador electrónico
220/240V remoto incluido.

LED recessed downlight.
Remote electronic
transformer 220/240V
included.

- 2700K
Non Dimmable
03.4589.B1
Dali Version
03.4589.B1.DA
1-10V
03.4589.B1.1V
- 3000K
Non Dimmable
03.4588.B1
Dali Version
03.4588.B1.DA
1-10V
03.4588.B1.1V

- 2700K
Non Dimmable
03.4589.GL
Dali Version
03.4589.GL.DA
1-10V
03.4589.GL.1V

- 3000K
Non Dimmable
03.4588.GL
Dali Version
03.4588.GL.DA
1-10V
03.4588.GL.1V

- 2700K
Non Dimmable
03.4589.BU
Dali Version
03.4589.BU.DA
1-10V
03.4589.BU.1V

- 3000K
Non Dimmable
03.4588.BU
Dali Version
03.4588.BU.DA
1-10V
03.4588.BU.1V

- 2700K
Non Dimmable
03.4589.74
Dali Version
03.4589.74.DA
1-10V
03.4589.74.1V

- 3000K
Non Dimmable
03.4588.74
Dali Version
03.4588.74.DA
1-10V
03.4588.74.1V

- 2700K
Non Dimmable
03.4589.CU
Dali Version
03.4589.CU.DA
1-10V
03.4589.CU.1V

- 3000K
Non Dimmable
03.4588.CU
Dali Version
03.4588.CU.DA
1-10V
03.4588.CU.1V

Marco de pre-instalación. Se ha de pedir por separado.

Pre-installation frame. To be ordered separately.

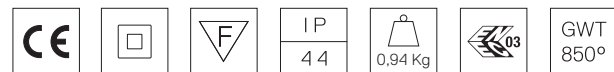

LED INCL.
NOT REPLACEABLE

KAP

KAP Ø145 WALL-WASHER

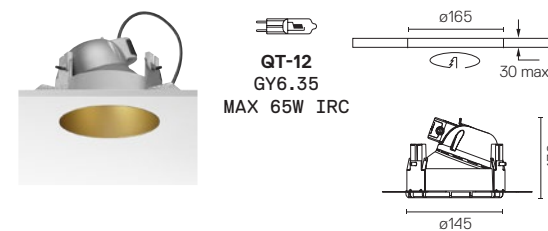

QT-12
GY6.35
MAX 65W IRC

Empotrable para lámpara
halógena de 12V.
Transformador remoto no
incluido.

12V halogen lamp
recessed downlight.
Remote transformer not
included.

- 03.4471.B1
03.4471.GL
03.4471.BU
03.4471.74
03.4471.CU

Marco de pre-instalación. Se ha de pedir por separado.

Pre-installation frame. To be ordered separately.



KAP Ø145 WALL-WASHER

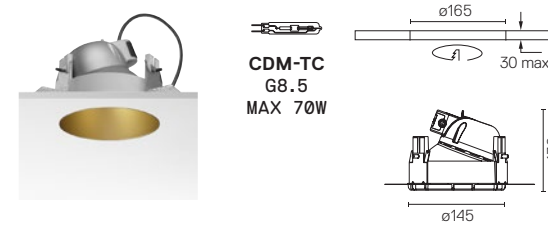

CDM-TC
G8.5
MAX 70W

Empotrable para lámpara
de halogenuro metálico.
Balasto no incluido.

Metal halide lamp
recessed downlight.
Remote control gear not
included.

- 03.4470.B1
03.4470.GL
03.4470.BU
03.4470.74
03.4470.CU

Marco de pre-instalación. Se ha de pedir por separado.

Pre-installation frame. To be ordered separately.



Crerios: Número de luminarias n>5
Criteria: Number of luminaires n>5
Altura del techo 3 m
Heigh of the ceiling 3 m
Distancia a la pared (m)
Distance to the wall (m)
0,75 0,75 1,00 1,00

Interdistancia entre luminarias (m)
Distance between the luminaires (m)
0,75 1,00 1,00 1,25

Iluminancia QT-12 75W (lx)
Illuminance QT-12 75W (lx)
161 124 108 88

Crerios: Número de luminarias n>5
Criteria: Number of luminaires n>5
Altura del techo 3 m
Heigh of the ceiling 3 m
Distancia a la pared (m)
Distance to the wall (m)
0,75 0,75 1,00 1,00

Interdistancia entre luminarias (m)
Distance between the luminaires (m)
0,75 1,00 1,00 1,25

Iluminancia CDM-TC 35W (lx)
Illuminance CDM-TC 35W (lx)
368 285 246 201

Distancia a la pared (m)
Distance to the wall (m)
1,00 1,00 1,25 1,25

Interdistancia entre luminarias (m)
Distance between the luminaires (m)
1,00 1,25 1,25 1,50

Iluminancia CDM-TC 70W (lx)
Illuminance CDM-TC 70W (lx)
471 385 332 282

Kit de Instalación Fast&Perfect
Fast&Perfect Installation Kit

Marco de instalación No Trim.
Kap ø80.  Kap ø80 Round
□ 08.9102.00

Installation frame No Trim.
Kap ø80.  + 08.9100.00

Herramienta Fast&Perfect.
Fast&Perfect tool.  ø123

Marco de instalación No Trim.
Kap □80.  Kap 80 Square
□ 08.9103.00

Installation frame No Trim.
Kap □80.  + 08.9101.00

Herramienta Fast&Perfect.
Fast&Perfect tool.  ø153

Marco de instalación No Trim.
Kap ø105.  Kap ø105 Round
□ 08.9104.00

Installation frame No Trim.
Kap ø105.  + 08.9101.00

Herramienta Fast&Perfect.
Fast&Perfect tool.  ø153

Sistema de Instalación Fast&Perfect
Fast&Perfect Installation System

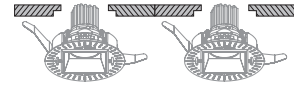

ø80: min 135 mm
□80: min 165 mm
ø105: min 165 mm

Marco de instalación No Trim.
Kap ø105/□105.  Kap ø105 Round
□ 08.8155.00

Installation frame No Trim.
Kap ø105/□105.  Kap 105 Square
□ 08.8479.00

Marco de instalación No Trim.
Kap ø145/ø145 Wall-Washer.  Kap ø145
□ 08.8156.00

Installation frame No Trim.
Kap ø145/ø145 Wall-Washer.  ø165
□ 08.8251.00

Marco de instalación Trim.
Kap ø145/ø145 Wall-Washer.  Kap ø145 W-W
□ 08.8491.30

Installation frame Trim.
Kap 145/ø145 Wall-Washer.  ø155
□ 08.8491.GL
□ 08.8491.BU
□ 08.8491.14
*

Can de instalación para cemento.
Kap ø105/ø145.  Kap ø105
□ 08.8420.00

Installation can for concrete.
Kap ø105/ø145.  Kap ø145
□ 08.8421.00

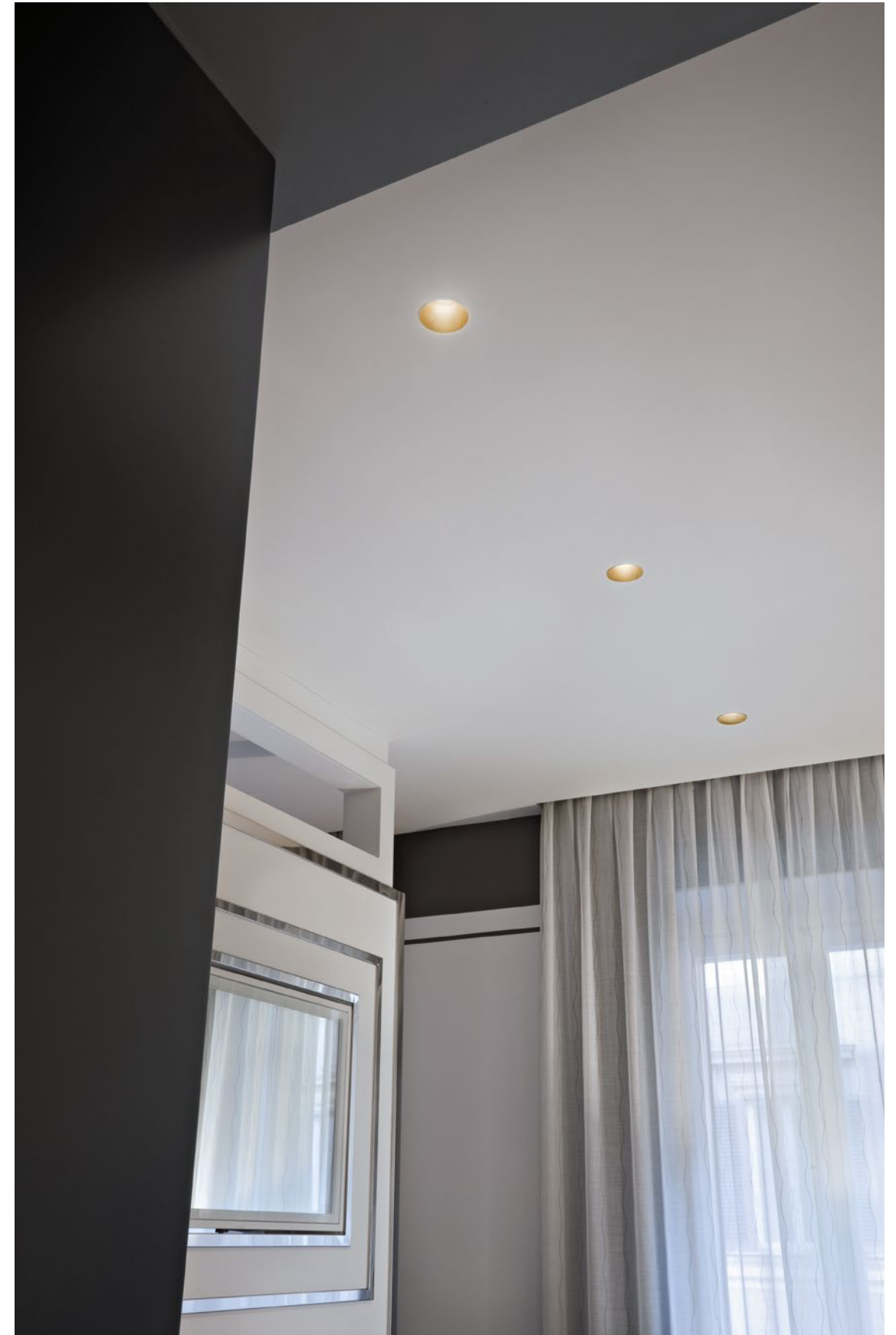

* Marco de instalación Trim en cobre no disponible. Se puede combinar con blanco o cualquiera de los otros decorados disponibles según el efecto estético desado.
Copper finish trim frame not available. Combine with white or any of the other finishes according to the desired final aesthetic effect.



Todos los Easy Kap 80 llevan incluido un difusor opal que puede montarse para aumentar el confort visual y el apantallamiento de la luminaria.

All the Easy Kap 80 have an opaline diffuser that can be assembled to increase visual comfort and screening of the luminaire.



Efecto No Trim gracias a un nuevo sistema de montaje. Fácil mantenimiento de la lámpara sin necesidad de herramientas gracias a su montaje en bayoneta.

Total No Trim effect achieved due to a new installation system. The bayonet-based assembly allows to replace the lamp without using any particular tools.

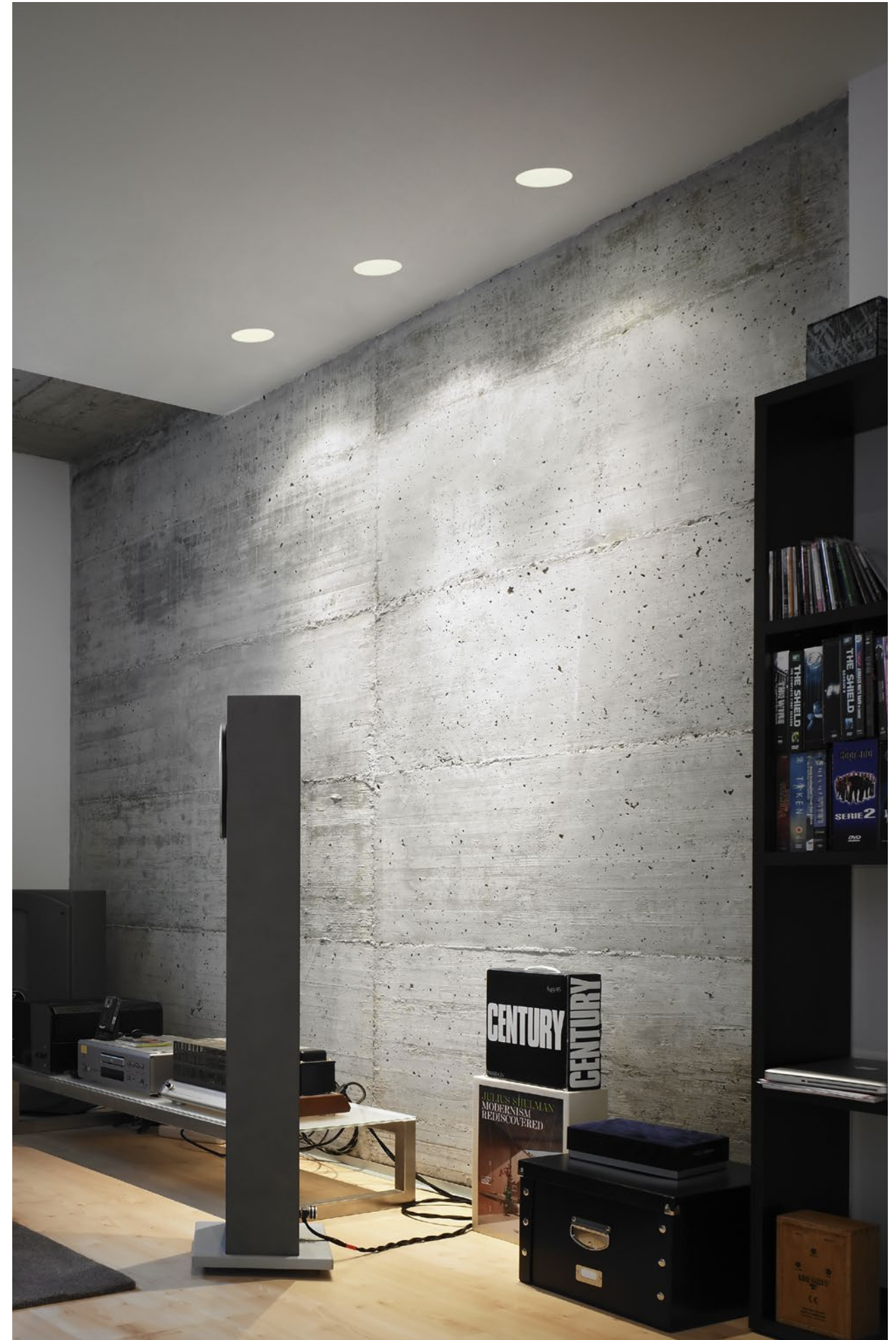



La luminaria incluye en su cuerpo principal un elemento radiador con el fin de controlar la correcta temperatura de trabajo de la misma.

The main body of the luminaire contains a radiator for temperature control.



El cuerpo de empotramiento incorpora un difusor realizado en material termoplástico para obtener una perfecta distribución de luz en planos horizontales.

The remote housing includes a thermoplastic diffuser which ensures a perfect light distribution on horizontal surfaces.



En los KAP 80 y, como opción en los KAP 105 y Square, el marco de instalación trim se instala con el sistema rápido Fast&Perfect exclusivo de FLOS.

In the KAP 80 and, as an option in the KAP 105 and Square, the trim installation frame is installed with the exclusive FLOS Fast&Perfect system.



Disponible can para instalación en techo de cemento.

Available with for the installation in cement ceilings.

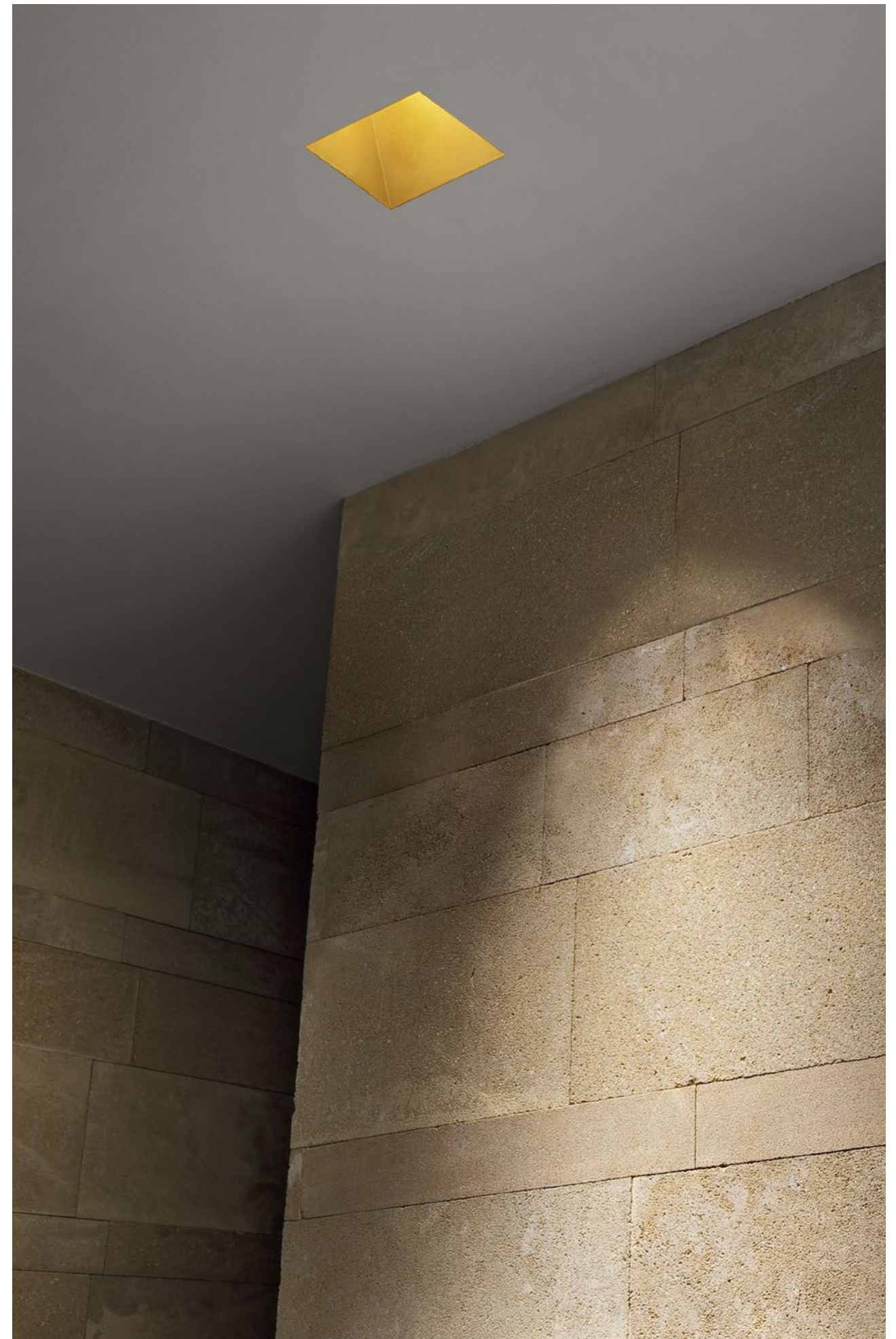

JOHNNY

Proyector versátil gracias a los dos tamaños disponibles y a la gran variedad de posibilidades de instalación. Posibilidad de máxima integración en la versión empotrada, o de mayor presencia estética en las versiones semi-empotradas con acabados en materiales exclusivos. Dotado de sistema mecánico de rotación que garantiza su eficiencia, integración y estabilidad en el tiempo. Incluye versiones para instalación rápida sin marco con nuestro sistema Fast&Perfect.

JOHNNY

Versatile projector thanks to the two available sizes and the great variety of installation possibilities. Possibility of maximum integration in the embedded version, or of a larger aesthetic presence in the semi-embedded versions with exclusive finishes. Fitted with a mechanical rotation system that ensures efficiency, integration and stability over time. Includes different versions for a fast frame-free installation with the Fast&Perfect system.



DESIGNED BY FLOS ARCHITECTURAL





Descripción

Sistema de iluminación de uno o dos focos orientables, en versión empotrada (Trim y No Trim) y semi-empotrada para ser instalado en techo. Disponible en dos tamaños: 80mm y 120mm en versiones redonda y cuadrada. Sistema de orientación exclusivo de fácil fijación permitiendo la precisa orientación del haz de luz. Versión Ø80mm empotrada No Trim disponible con sistema de instalación exclusivo Fast&Perfect.

Unidades de Alimentación

Fuente de alimentación de corriente constante 220/240V remota no incluida.

Accesorios

- cilindro de apantallamiento con cruceta incorporada
- lente elíptica (Johnny 120)
- lente Flood (Johnny 120)
- honeycomb

Información Adicional

Sistema de orientación integrado en cuerpo telescópico para la versión Johnny 80. Índice de protección IP20. Instalable en superficies normalmente inflamables.

Cumplimiento de Normativa y Marcas de Calidad

Luminaria conforme con la Normativa Técnica Europea EN60598-1 y partes segundas.

Description

Illumination system consisting of one or two adjustable lights, in the embedded version (Trim and No Trim) and semi-embedded version to be installed on the ceiling. Available in two sizes: 80 mm and 120 mm in round and square versions. An exclusive, easy and adjustable system that enables an accurate adjustment of the light beam. The No Trim Ø80 mm version comes with the exclusive Fast&Perfect installation system.

Power Supply

Remote constant power supply 220/240V not included.

Accessories

- screening cylinder with incorporated crosspiece
- elliptical lens (Johnny 120)
- flood lens (Johnny 120)
- honeycomb

Additional Information

The Johnny 80 version has a orientation system integrated into the telescopic body. IP20 protection grade. Suitable for installation on normally inflammable surfaces.

Standard Compliance and Quality Marks

EN60598-1 European Technical Standards and any subsequent additions.

**Colores
Colours**

Johnny 80 Trim



- 14 Negro
- 14 Black

Johnny 80 / 120 No Trim



- 14 Negro
- 14 Black

Johnny 120 Trim

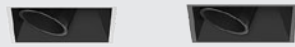

- 40 Blanco
- 40 White
- 14 Negro
- 14 Black

Johnny 80 / 120 Semi-Recessed



- 40 Blanco
- 40 White
- CE Cemento
- CE Concrete
- TK Teca
- TK Teak
- 14 Negro
- 14 Black

**Rotación
Rotation Features**

Puede ser rotado 40° en cualquier dirección.
Can be rotated 40° in any direction.

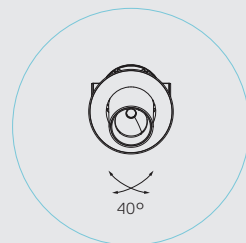

**JOHNNY 80
TRIM / NO TRIM
1L ROUND / 1L SQUARE
2L SQUARE**



**JOHNNY 80
SEMI-RECESSED
1L SQUARE /
2L SQUARE**



POWER LED
8W
560 1m
2700K/CRI 90
8W
600 1m
3000K/CRI 90

**JOHNNY 120
TRIM / NO TRIM
1L ROUND / 1L SQUARE
2L SQUARE**



**JOHNNY 120
SEMI-RECESSED
1L SQUARE /
2L SQUARE**

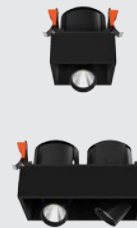

LED ARRAY
18W
1555 1m
2700K/CRI 90
18W
1600 1m
3000K/CRI 90

JOHNNY

JOHNNY Ø80 TRIM 1L ROUND

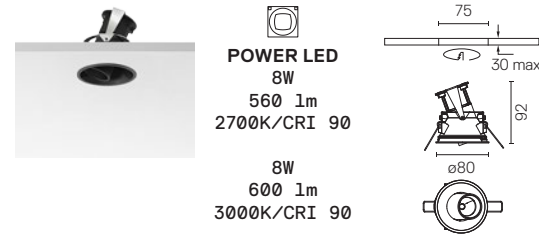

[JOHNNY Ø80 NO TRIM] 1L ROUND



Equipos recomendados:
Recommended power supply:

- Non Dimmable 60.8880
- Dimmable 1-10V 60.8533
- Dimmable Dali 60.8847
- Mains Dimming 60.8534

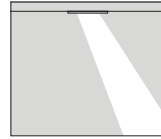

LED INCL.
NOT REPLACEABLE

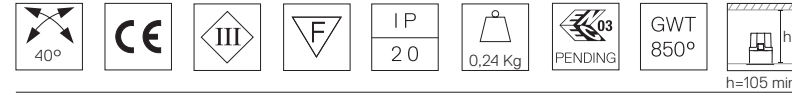

Luminaria empotrable para fuente de luz LED. Fuente de alimentación no incluida.

- 2700K 03.0701.14
- 3000K 03.0701.14.NT

Embedded luminaire for LED light source. Power supply not included.

- 2700K 03.0705.14
- 3000K 03.0705.14.NT
- 3000K 03.0704.14
- 3000K 03.0704.14.NT

- 2700K 03.0709.14
- 3000K 03.0709.14.NT

- 2700K 03.0708.14
- 3000K 03.0708.14.NT



JOHNNY

JOHNNY 80 TRIM 2L SQUARE

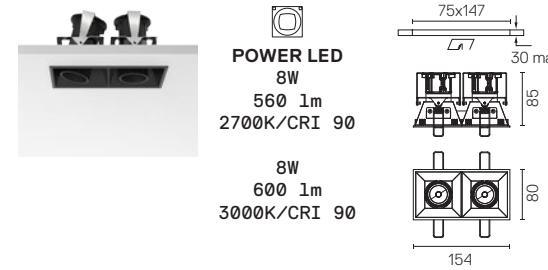

[JOHNNY 80 NO TRIM] 2L SQUARE



Equipos recomendados:
Recommended power supply:

- Non Dimmable 60.8880
- Dimmable 1-10V 60.8533
- Dimmable Dali 60.8847
- Mains Dimming 60.8534

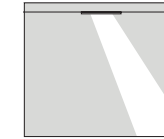

LED INCL.
NOT REPLACEABLE

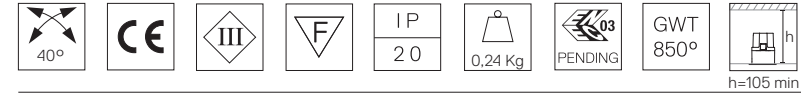

Luminaria empotrable para fuente de luz LED. Fuente de alimentación no incluida.

- 2700K 03.0713.14
- 3000K 03.0713.14.NT

Embedded luminaire for LED light source. Power supply not included.

- 2700K 03.0715.14
- 3000K 03.0715.14.NT
- 3000K 03.0714.14
- 3000K 03.0714.14.NT

- 2700K 03.0717.14
- 3000K 03.0717.14.NT

- 2700K 03.0716.14
- 3000K 03.0716.14.NT



JOHNNY 80 TRIM 1L SQUARE

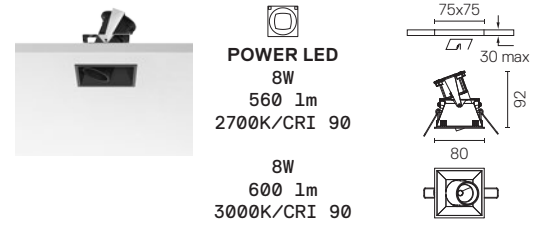

[JOHNNY 80 NO TRIM] 1L SQUARE



Equipos recomendados:
Recommended power supply:

- Non Dimmable 60.8880
- Dimmable 1-10V 60.8533
- Dimmable Dali 60.8847
- Mains Dimming 60.8534

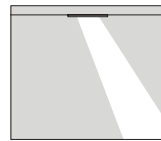

LED INCL.
NOT REPLACEABLE

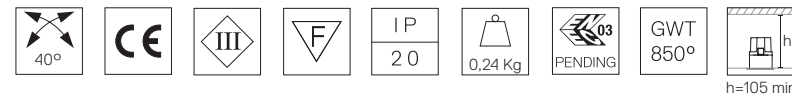

Luminaria empotrable para fuente de luz LED. Fuente de alimentación no incluida.

- 2700K 03.0703.14
- 3000K 03.0703.14.NT

Embedded luminaire for LED light source. Power supply not included.

- 2700K 03.0707.14
- 3000K 03.0707.14.NT
- 3000K 03.0702.14
- 3000K 03.0702.14.NT

- 2700K 03.0707.14
- 3000K 03.0707.14.NT

- 2700K 03.0711.14
- 3000K 03.0711.14.NT

- 2700K 03.0710.14
- 3000K 03.0710.14.NT



JOHNNY 80 SEMI-RECESSED 1L SQUARE

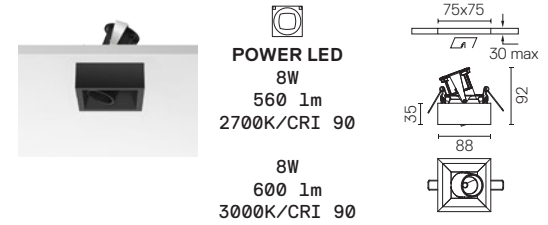

Equipos recomendados:
Recommended power supply:

- Non Dimmable 60.8880
- Dimmable 1-10V 60.8533
- Dimmable Dali 60.8847
- Mains Dimming 60.8534

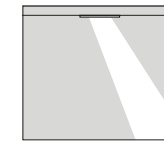

LED INCL.
NOT REPLACEABLE

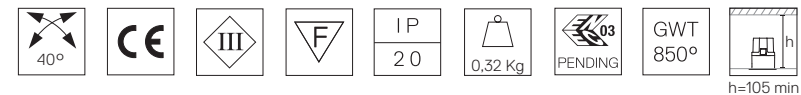

Luminaria semi-empotrable para fuente de luz LED. Fuente de alimentación no incluida.

- 2700K 03.0719.40
- 2700K 03.0719.CE
- 2700K 03.0719.TK
- 2700K 03.0719.14

Semi-recessed luminaire for LED light source. Power supply not included.

- 3000K 03.0718.40
- 3000K 03.0718.CE
- 3000K 03.0718.TK
- 3000K 03.0718.14

- 2700K 03.0721.40
- 2700K 03.0721.CE
- 2700K 03.0721.TK
- 2700K 03.0721.14

- 3000K 03.0720.40
- 3000K 03.0720.CE
- 3000K 03.0720.TK
- 3000K 03.0720.14

- 2700K 03.0723.40
- 2700K 03.0723.CE
- 2700K 03.0723.TK
- 2700K 03.0723.14

- 3000K 03.0722.40
- 3000K 03.0722.CE
- 3000K 03.0722.TK
- 3000K 03.0722.14



[Marco de pre-instalación Fast&Perfect. Se ha de pedir por separado.]
Fast&Perfect pre-installation frame. To be ordered separately.

JOHNNY

JOHNNY 80 SEMI-RECESSED 2L SQUARE



POWER LED
8W
560 lm
2700K/CRI 90

8W
600 lm
3000K/CRI 90

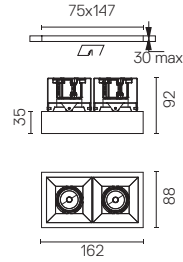

Luminaria semi-empotrable para fuente de luz LED. Fuente de alimentación no incluida.

Semi-recessed luminaire for LED light source. Power supply not included.

2700K
03.0731.40
03.0731.CE
03.0731.TK
03.0731.14

3000K
03.0730.40
03.0730.CE
03.0730.TK
03.0730.14

2700K
03.0733.40
03.0733.CE
03.0733.TK
03.0733.14

3000K
03.0732.40
03.0732.CE
03.0732.TK
03.0732.14

2700K
03.0735.40
03.0735.CE
03.0735.TK
03.0735.14

3000K
03.0734.40
03.0734.CE
03.0734.TK
03.0734.14

Equipos recomendados:
Recommended power supply:

Non Dimmable 60.8880
Dimmable 1-10V 60.8533
Dimmable Dali 60.8847
Mains Dimming 60.8534

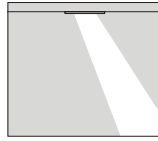

LED INCL.
NOT REPLACEABLE

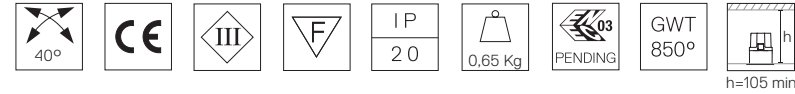

SPOT



MEDIUM



FLOOD

JOHNNY 80

ACCESORIOS / ACCESSORIES

Johnny 80

Cruceta de apantallamiento. 08.8455.00
Screening crosspiece.

Honeycomb. 08.8458.00

Honeycomb.

Johnny 80 No Trim 1L

Kit de Instalación Fast&Perfect Fast&Perfect Installation Kit

Marco de instalación No Trim. Johnny ø80. Johnny ø80 Round 08.9102.00

Installation frame No Trim. Johnny ø80. + Herramienta Fast&Perfect. 08.9100.00

Fast&Perfect tool. ø123

Marco de instalación No Trim. Johnny □80. Johnny 80 Square 08.9103.00

Installation frame No Trim. Johnny □80. + Herramienta Fast&Perfect. 08.9101.00

Fast&Perfect tool. ø153

Sistema de Instalación Fast&Perfect Fast&Perfect Installation System



ø80: min 135 mm
□80: min 165 mm

JOHNNY

JOHNNY 120 LIGHT SOURCE



LED ARRAY
DC 500 mA
18W
1555 lm
2700K/CRI 90

18W
1600 lm
3000K/CRI 90

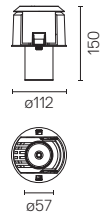

Luminaria empotrable para fuente de luz LED. Fuente de alimentación no incluida.

Embedded luminaire for LED light source. Power supply not included.

2700K
■ 03.0741.14

3000K
■ 03.0740.14

2700K
■ 03.0743.14

3000K
■ 03.0742.14

2700K
■ 03.0745.14

3000K
■ 03.0744.14



Equipos recomendados:
Recommended power supply:

Non Dimmable 60.8880
Dimmable 1-10V 60.8536
Dimmable Dali 60.8847
Mains Dimming 60.8534

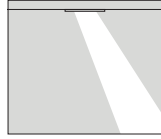

(JOHNNY 120) TRIM BOX 1L ROUND



08.0505.40
08.0505.14
+
1xLight Source

(JOHNNY 120) TRIM BOX 1L SQUARE



08.0500.40
08.0500.14
+
1xLight Source

(JOHNNY 120) TRIM BOX 2L SQUARE

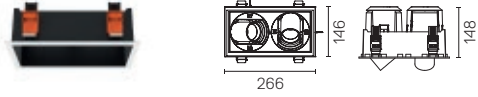

08.0501.40
08.0501.14
+
2xLight Source

(JOHNNY 120) NO TRIM BOX 1L ROUND



08.0503.14
+
1xLight Source

(JOHNNY 120) NO TRIM BOX 1L SQUARE



08.0502.14
+
1xLight Source

(JOHNNY 120) NO TRIM BOX 2L SQUARE

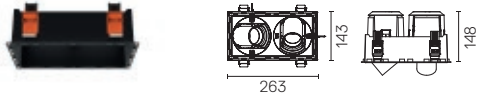

08.0504.14
+
2xLight Source

(JOHNNY 120) SEMI-RECESSED BOX 1L SQUARE

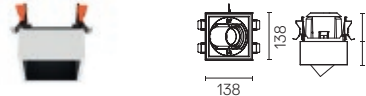

08.0506.40
08.0506.CE
08.0506.TK
08.0506.14
+
1xLight Source

(JOHNNY 120) SEMI-RECESSED BOX 2L SQUARE

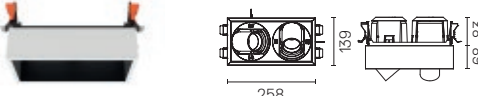

08.0507.40
08.0507.CE
08.0507.TK
08.0507.14
+
2xLight Source

JOHNNY

HOW TO ORDER JOHNNY 120

Ejemplo / Example:

Recessed

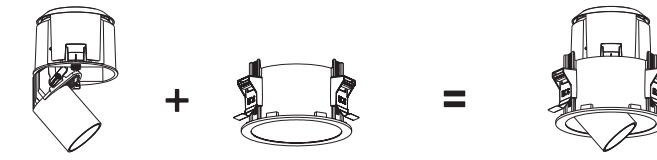

1xLight Source

Trim Box 1L Round

Johnny 120 Trim 1L Round

Semi-Recessed

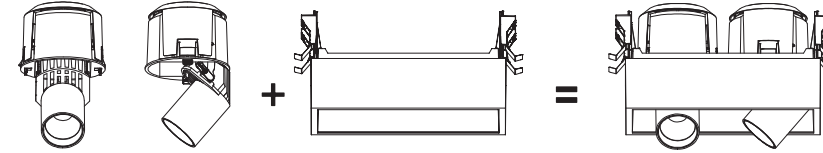

2xLight Source

Semi-Recessed Box 2L Square

Johnny 120 Semi-Recessed 2L Square

Accesorios
Accessories
Johnny 120

Cruceta de apantallamiento.

Screening crosspiece.



08.8429.00

Lente elíptica.

Elliptical lens.



08.8431.00

Lente Flood.

Flood lens.



08.8432.00

Honeycomb.

Honeycomb.



08.8428.00



Johnny 80 / Johnny 80 Semi-empotrado: sistema de orientación basculante que permite sacar la cabeza del proyector para su correcta orientación.

Johnny 120 / Johnny 120 Semi-empotrado: sistema de orientación mecánico que permite sacar la cabeza del proyector para su correcta orientación.

Johnny 80 / Johnny 80 Semi-embedded: with the tilt orientation system the spotlight head can be pulled and tilted in the desired direction.

Johnny 120 / Johnny 120 Semi-embedded: a mechanic orientation system that enables pulling the head out of the projector for a correct orientation.



Box para instalación semi-empotrada. Disponible en acabados cemento, teca, blanco o negro según las versiones.

Box for semi-embedded installation. Available with cement, teak, white or black finishes, according to the versions.

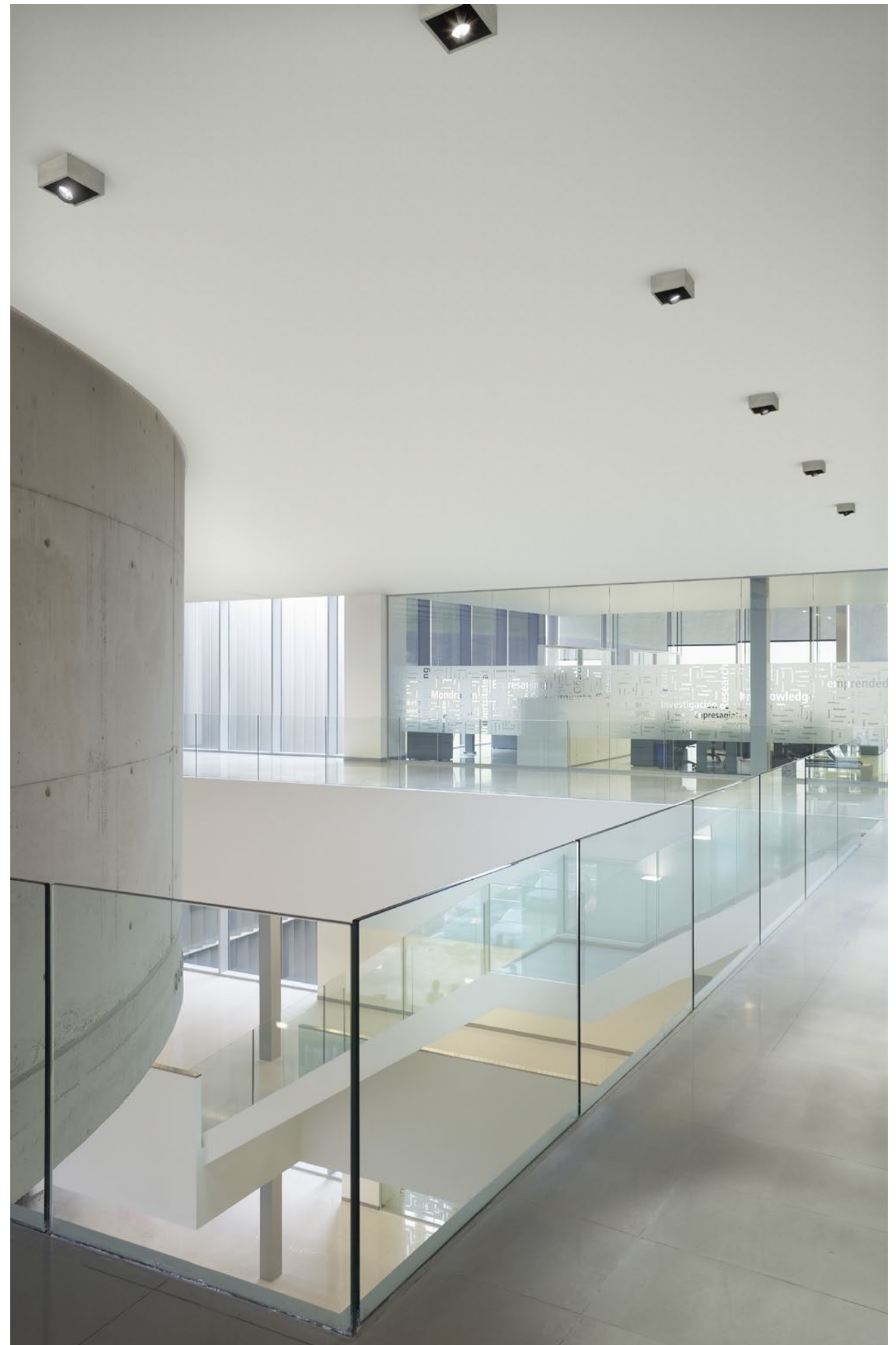

LIGHT SUPPLY

Empotrables de alta potencia con módulos de LED de última generación. Tamaño compacto que supone la máxima integración en la arquitectura. Disponible en versiones fija, wall-washer y ajustable, también con accesorios profesionales de apantallamiento.

LIGHT SUPPLY

High-power embedded elements with avant-garde LED modules. Compact size with maximum integration into the architecture. Comes in fixed, wall-washer and adjustable versions, with professional screening accessories.



DESIGNED BY FLOS ARCHITECTURAL







Descripción

Nueva familia de empotrables desarrollada para conseguir un flujo máximo de 3000 lm dentro de un diseño compacto de 165mm de diámetro gracias a la última tecnología de módulos LED.

Disponibles en versiones fija, ajustable y wall-washer.

La versión ajustable cuenta con una óptica cilíndrica intercambiable para facilitar el acceso a la electrónica e intercambiar los accesorios disponibles.

Para ofrecer la máxima flexibilidad y mejorar la instalación, hay disponibles reflectores con ópticas cerradas, intermedias y abiertas. Intercambio de accesorios sin necesidad de desmontar el producto del techo.

Todas las versiones No Trim pueden ser montadas en marco de pre-instalación o integradas en techo de cartón yeso mediante la tecnología Soft.

Acabados disponibles para versiones fija, Wall-Washer y ajustable Trim: negro (14) o blanco (40).

La versión fija Trim está disponible con aro externo negro o blanco combinado con reflectores internos blanco o cromo.

Reflectores

Realizados con aluminio en acabado especular. Para la versión ajustable haz de luz cerrado, medio y amplio; para la versión fija aperturas amplias.

Unidades de Alimentación

Cableado incluido, disponible para conectar a equipo remoto. Versiones sin equipo y regulable 1-10V disponibles bajo pedido.

Accesorios

Para la versión ajustable:

- lente de distribución elíptica.
- rejilla antideslumbramiento realizada en celdas de aluminio.
- recambio de reflectores con aperturas cerrada, media y abierta.

Para todas las versiones No Trim:

- marco de pre-instalación o placa de instalación Soft Architecture para la versión ajustable.

Información Adicional

En las versiones ajustables, basculación de 35° y rotación de 365°.

Índice de protección IP23, IP44 según las versiones.

Clase de aislamiento II.

Cumplimiento de Normativa y Marcas de Calidad

Luminaria conforme con la Normativa Técnica Europea EN60598-1 y partes segundas.

Description

New downlight family developed to get a maximum flux in a compact design. 165mm diameter offering up to 3000 lm thanks to latest technology LED modules.

Available in fixed, adjustable and wall-washer version.

Adjustable version features a dismantlable optic support cylinder, to be easily unscrewed from the luminaire, in order to completely access the electronic and to install the professional accessories available.

To offer maximum flexibility and installation evolution in time, reflector of spot, medium and flood optic are also available as accessories, to change the light beam dimension without even needing to dismount the fixture from the ceiling.

All Light Supply No Trim versions can be mounted in a standard pre-installation metal frame or, for total integration in plasterboard ceiling, in a Soft Technology installation plate.

Available finishes: black (14) and white (40) for Fixed Trim, Wall-Washer and Adjustable version.

The Fixed Trim version is available with external ring black or white combined with internal white or chrome reflector.

Reflectors

All super pure aluminum with specular finish. Circular roto symmetrical spot, medium and flood for the adjustable version, flood for the fixed version.

Power Supply

Cabling included, ready to be powered by included remote driver.

Versions without driver and 1-10V dimmable available on request.

Accessories

For adjustable version:

- elliptical distribution lens.
- anti-glare grid in aluminium cells with black liquid paint finish.
- spare part of spot, medium, flood optics reflectors.

For all No Trim versions:

- pre-installation frame or Soft Architecture installation plate for adjustable version.

Additional Information

In the adjustable versions, 35° tilt and 365° rotation.

IP23, IP44 protection grade depending on the versions.

Insulation class II.

Standard Compliance and Quality Marks

EN60598-1 European Technical Standards and any subsequent additions.

FIXED TRIM / NO TRIM	ADJUSTABLE TRIM / NO TRIM	WALL-WASHER TRIM / NO TRIM
PHOSPHOR LED 26W 2285 lm 3000K CRI 98	PHOSPHOR LED 28W 3000 lm 4000K CRI 80	LED ARRAY HIGH PERFORMANCES 32W 3800 lm 3000K/CRI 80 3000 lm 3000K/CRI 90 3350 lm 4000K/CRI 90

Colores / Colours 40 Blanco / 40 White 14 Negro / 14 Black



Fixed & Wall-Washer Trim

Anillo Exterior/ External Ring Blanco / White Negro / Black

Reflector/ Reflector Aluminio / Aluminium Blanco / White Aluminio / Aluminium Blanco / White



Rotación / Rotation Features Puede ser rotado 365° y orientado 35°. / Can be rotated 365° and swivelled 35°.

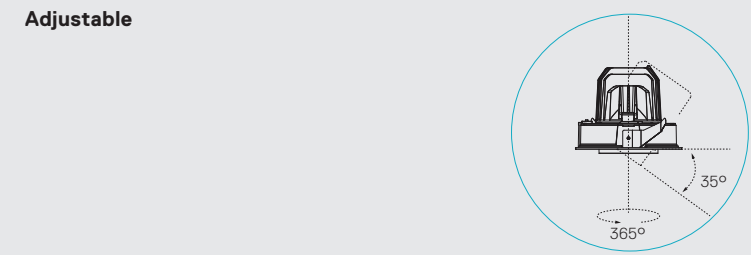

LIGHT SUPPLY



Gracias a la remote-phosphor technology, los módulos LED que montan las versiones Phosphor LED ofrecen la máxima calidad de luz posible, percepción de los objetos y espacios, alcanzando índices de reproducción cromática de 98, dependiendo de las versiones. Todas las versiones de 3000K están disponibles bajo petición en la "versión Retail". Esta opción cuenta con un módulo Phosphor LED especial que, con todas las ventajas en términos de ahorro energético y fiabilidad disponibles en el mercado, reproduce la frecuencia de la luz de una lámpara de halogenuro metálico. Esta solución innovadora mejora la percepción de los colores y la representación del color blanco, además de reducir la radiación del espectro violeta, perjudicial para obras de arte, así que, es especialmente indicado para su aplicación comercial y en museos. Los módulos LED instalados en las versiones LED Array cuentan con la última generación tecnológica que permite una menor temperatura media en el funcionamiento de la electrónica. Gracias a esta característica, la luminaria puede operar dentro de parámetros de seguridad a una mayor potencia, ofreciendo un aumento del 20% del flujo luminoso.

Thanks to remote-phosphor technology, the LED modules of the Phosphor LED version offer maximum quality light, the perception of objects and spaces, reaching chromatic reproduction indices of 98, depending on the version. All the 3000K versions are available under request in the "Retail version". This option has a special Phosphor LED module that, with all the advantages regarding energy saving and reliability available on the market, reproduces the frequency of the light of a metal halide lamp. This innovative solution improves the perception of colours and the representation of white, in addition to reducing the radiation of the violet spectrum, damaging to works of art, so, it is especially indicated for commercial and museum purposes. The LED modules installed on the LED Array versions have cutting-edge technology that permit a lower average temperature in the electronics. Thanks to this feature, the luminaire can operate at a higher power inside the safety parameters, yet still offer 20% added luminous flux.

Equipo remoto incluido regulado a máxima potencia, sin embargo, si la instalación requiere diferentes valores de lúmenes el mismo equipo puede ser regulado fácilmente para obtener la luz deseada.

The remote driver is provided with the setting for the maximum available power for this device. However, if the installation requires different lumen inputs or to reduce power consumption, the same driver can be easily set according to this scheme, to obtain the required light emission.

Driver current (mA)	CRI 80		CRI 98	
	Luminous flux of luminaire up to (lm)	Power (W)	Luminous flux of luminaire up to (lm)	Power (W)
1000	3000	28	2285 lm / 800 mA	26W / 800 mA
700	2100	18,9	2140	22,3
500	1585	13,2	1580	15,6
350	1195	9,1	1240	10,8

LIGHT SUPPLY

LIGHT SUPPLY FIXED TRIM



PHOSPHOR LED
26W
2285 lm
3000K/CRI 98

28W
3000 lm
4000K/CRI 80

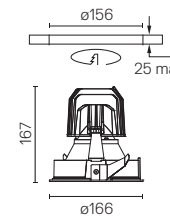

Luminaria empotrable para fuente de luz LED. Fuente de alimentación remota 220/240V incluida.

Embedded luminaire for LED light source. Remote 220/240V power supply included.

3000K - CRI 98 TRIM
E I
03.6611.3B
03.6611.3C
Dali Version/1-10V
03.6611.3B.DA
03.6611.3C.DA

03.6611.1B
03.6611.1C
Dali Version/1-10V
03.6611.1B.DA
03.6611.1C.DA

NO TRIM
03.6626.40
03.6626.06
Dali Version/1-10V
03.6626.40.DA
03.6626.06.DA

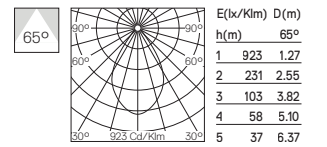

WHITE REFLECTOR

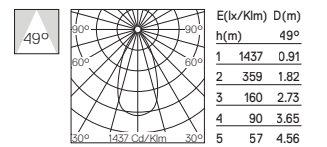

ALUMINIUM REFLECTOR

[LIGHT SUPPLY FIXED NO TRIM]

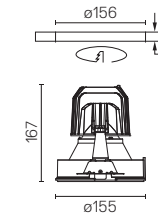

LED INCL.
NOT REPLACEABLE

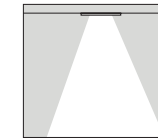

4000K - CRI 80 TRIM
E I
03.6610.3B
03.6610.3C
Dali Version/1-10V
03.6610.3B.DA
03.6610.3C.DA

03.6610.1B
03.6610.1C
Dali Version/1-10V
03.6610.1B.DA
03.6610.1C.DA

NO TRIM
03.6625.40
03.6625.06
Dali Version/1-10V
03.6625.40.DA
03.6625.06.DA

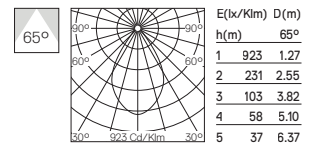

WHITE REFLECTOR

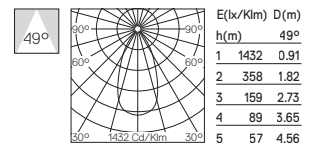

ALUMINIUM REFLECTOR

E= Acabado Externo / I= Acabado Interno.
E= External Finish / I= Internal Finish.

[Marco de pre-instalación. Se ha de pedir por separado.]
[Pre-installation frame. To be ordered separately.]

LIGHT SUPPLY

LIGHT SUPPLY ADJUSTABLE TRIM



**PHOSPHOR
LED
26W**
2285 lm
3000K
CRI 98

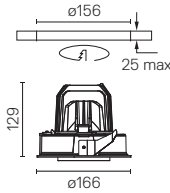

Luminaria empotrable para fuente de luz LED. Fuente de alimentación remota 220/240V incluida.

Embedded luminaire for LED light source. Remote 220/240V power supply included.

- 3000K - CRI 98
TRIM
 03.6606.40
 03.6606.14
 Dali Version/1-10V
 03.6606.40.DA
 03.6606.14.DA
 NO TRIM
 03.6621.40
 03.6621.14
 Dali Version/1-10V
 03.6621.40.DA
 03.6621.14.DA

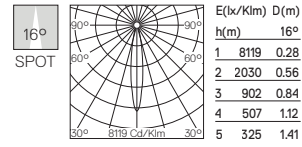

[LIGHT SUPPLY ADJUSTABLE NO TRIM]

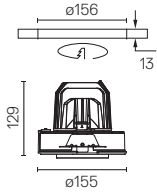

- 3000K - CRI 98
TRIM
 03.6607.40
 03.6607.14
 Dali Version/1-10V
 03.6607.40.DA
 03.6607.14.DA
 NO TRIM
 03.6622.40
 03.6622.14
 Dali Version/1-10V
 03.6622.40.DA
 03.6622.14.DA

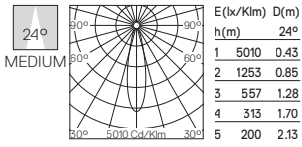

LED INCL.
NOT REPLACEABLE

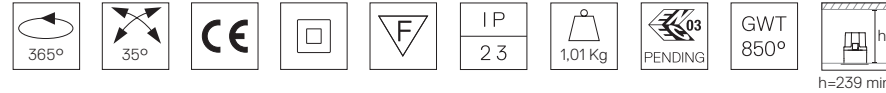

- 3000K - CRI 98
TRIM
 03.6608.40
 03.6608.14
 Dali Version/1-10V
 03.6608.40.DA
 03.6608.14.DA
 NO TRIM
 03.6623.40
 03.6623.14
 Dali Version/1-10V
 03.6623.40.DA
 03.6623.14.DA

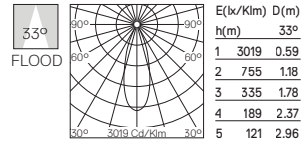

LIGHT SUPPLY ADJUSTABLE TRIM



**PHOSPHOR
LED
28W**
3000 lm
4000K
CRI 80

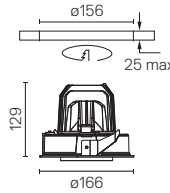

Luminaria empotrable para fuente de luz LED. Fuente de alimentación remota 220/240V incluida.

Embedded luminaire for LED light source. Remote 220/240V power supply included.

- 4000K - CRI 80
TRIM
 03.6603.40
 03.6603.14
 Dali Version/1-10V
 03.6603.40.DA
 03.6603.14.DA
 NO TRIM
 03.6618.40
 03.6618.14
 Dali Version/1-10V
 03.6618.40.DA
 03.6618.14.DA

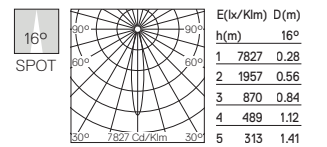

[LIGHT SUPPLY ADJUSTABLE NO TRIM]

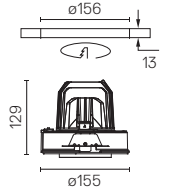

- 4000K - CRI 80
TRIM
 03.6604.40
 03.6604.14
 Dali Version/1-10V
 03.6604.40.DA
 03.6604.14.DA
 NO TRIM
 03.6619.40
 03.6619.14
 Dali Version/1-10V
 03.6619.40.DA
 03.6619.14.DA

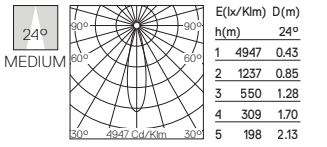

LED INCL.
NOT REPLACEABLE

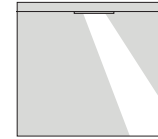

- 4000K - CRI 80
TRIM
 03.6605.40
 03.6605.14
 Dali Version/1-10V
 03.6605.40.DA
 03.6605.14.DA
 NO TRIM
 03.6620.40
 03.6620.14
 Dali Version/1-10V
 03.6620.40.DA
 03.6620.14.DA

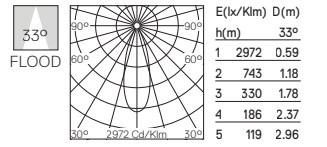

[Marco o Placa Soft Architecture para pre-instalación No Trim. Se ha de pedir por separado.
Pre-installation frame or Soft Architecture installation plate for No Trim installation. To be ordered separately.]

LIGHT SUPPLY

LIGHT SUPPLY ADJUSTABLE TRIM



**PHOSPHOR
LED
28W**
3000 lm
4000K
CRI 80

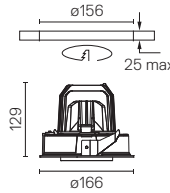

Luminaria empotrable para fuente de luz LED. Fuente de alimentación remota 220/240V incluida.

Embedded luminaire for LED light source. Remote 220/240V power supply included.

- 4000K - CRI 80
TRIM
 03.6603.40
 03.6603.14
 Dali Version/1-10V
 03.6603.40.DA
 03.6603.14.DA
 NO TRIM
 03.6618.40
 03.6618.14
 Dali Version/1-10V
 03.6618.40.DA
 03.6618.14.DA

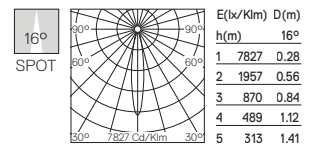

[LIGHT SUPPLY ADJUSTABLE NO TRIM]

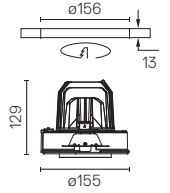

- 4000K - CRI 80
TRIM
 03.6604.40
 03.6604.14
 Dali Version/1-10V
 03.6604.40.DA
 03.6604.14.DA
 NO TRIM
 03.6619.40
 03.6619.14
 Dali Version/1-10V
 03.6619.40.DA
 03.6619.14.DA

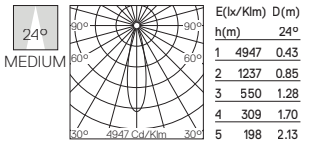

LED INCL.
NOT REPLACEABLE

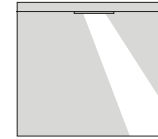

- 4000K - CRI 80
TRIM
 03.6605.40
 03.6605.14
 Dali Version/1-10V
 03.6605.40.DA
 03.6605.14.DA
 NO TRIM
 03.6620.40
 03.6620.14
 Dali Version/1-10V
 03.6620.40.DA
 03.6620.14.DA

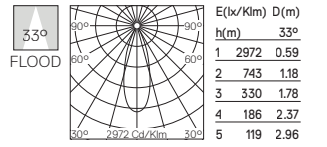

[Marco o Placa Soft Architecture para pre-instalación No Trim. Se ha de pedir por separado.
Pre-installation frame or Soft Architecture installation plate for No Trim installation. To be ordered separately.]

LIGHT SUPPLY

LIGHT SUPPLY WALL-WASHER TRIM

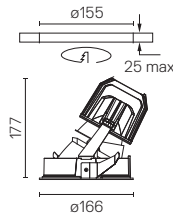
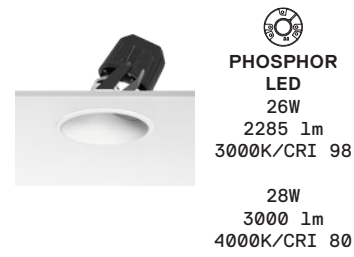

Luminaria empotrable para fuente de luz LED. Fuente de alimentación remota 220/240V incluida.

Embedded luminaire for LED light source. Remote 220/240V power supply included.

- 3000K - CRI 98
TRIM
- | E | I | Code |
|---|---|--------------------|
| □ | □ | 03.6614.3B |
| □ | ■ | 03.6614.3C |
| ■ | □ | 03.6614.3B.DA |
| ■ | ■ | 03.6614.3C.DA |
| ■ | □ | 03.6614.1B |
| ■ | ■ | 03.6614.1C |
| ■ | ■ | Dali Version/1-10V |
| ■ | □ | 03.6614.1B.DA |
| ■ | ■ | 03.6614.1C.DA |

- NO TRIM
- | | |
|---|--------------------|
| □ | 03.6629.40 |
| ■ | 03.6629.06 |
| ■ | Dali Version/1-10V |
| □ | 03.6629.40.DA |
| ■ | 03.6629.06.DA |

- 4000K - CRI 80
TRIM
- | E | I | Code |
|---|---|--------------------|
| □ | □ | 03.6613.3B |
| □ | ■ | 03.6613.3C |
| ■ | □ | 03.6613.3B.DA |
| ■ | ■ | 03.6613.3C.DA |
| ■ | □ | 03.6613.1B |
| ■ | ■ | 03.6613.1C |
| ■ | ■ | Dali Version/1-10V |
| ■ | □ | 03.6613.1B.DA |
| ■ | ■ | 03.6613.1C.DA |

- NO TRIM
- | | |
|---|--------------------|
| □ | 03.6628.40 |
| ■ | 03.6628.06 |
| ■ | Dali Version/1-10V |
| □ | 03.6628.40.DA |
| ■ | 03.6628.06.DA |

[LIGHT SUPPLY WALL-WASHER NO TRIM]



LED INCL.
NOT REPLACEABLE

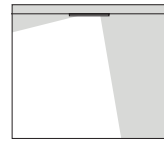

E= Acabado Externo / I= Acabado Interno.
E= External Finish / I= Internal Finish.

[Marco de pre-instalación. Se ha de pedir por separado.]
[Pre-installation frame. To be ordered separately.]

LIGHT SUPPLY

LIGHT SUPPLY FIXED TRIM

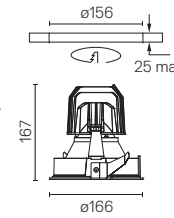
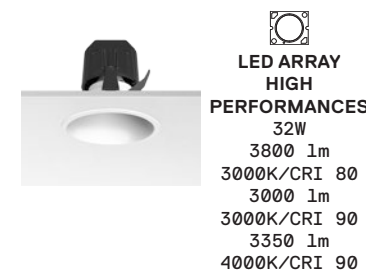

Luminaria empotrable para fuente de luz LED. Fuente de alimentación remota 220/240V incluida.

Embedded luminaire for LED light source. Remote 220/240V power supply included.

- 3000K - CRI 80
TRIM
- | E | I | Code |
|---|---|--------------------|
| □ | □ | 03.6809.3B |
| □ | ■ | 03.6809.3C |
| ■ | □ | 03.6809.3B.DA |
| ■ | ■ | 03.6809.3C.DA |
| ■ | □ | 03.6809.1B |
| ■ | ■ | 03.6809.1C |
| ■ | ■ | Dali Version/1-10V |
| ■ | □ | 03.6809.1B.DA |
| ■ | ■ | 03.6809.1C.DA |

- NO TRIM
- | | |
|---|--------------------|
| □ | 03.6824.40 |
| ■ | 03.6824.06 |
| ■ | Dali Version/1-10V |
| □ | 03.6824.40.DA |
| ■ | 03.6824.06.DA |

- 3000K - CRI 90
TRIM
- | E | I | Code |
|---|---|--------------------|
| □ | □ | 03.6811.3B |
| □ | ■ | 03.6811.3C |
| ■ | □ | 03.6811.3B.DA |
| ■ | ■ | 03.6811.3C.DA |
| ■ | □ | 03.6811.1B |
| ■ | ■ | 03.6811.1C |
| ■ | ■ | Dali Version/1-10V |
| ■ | □ | 03.6811.1B.DA |
| ■ | ■ | 03.6811.1C.DA |

- NO TRIM
- | | |
|---|--------------------|
| □ | 03.6826.40 |
| ■ | 03.6826.06 |
| ■ | Dali Version/1-10V |
| □ | 03.6826.40.DA |
| ■ | 03.6826.06.DA |

[LIGHT SUPPLY FIXED NO TRIM]



LED INCL.
NOT REPLACEABLE

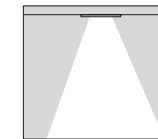

E= Acabado Externo / I= Acabado Interno.
E= External Finish / I= Internal Finish.

[Marco de pre-instalación. Se ha de pedir por separado.]
[Pre-installation frame. To be ordered separately.]

LIGHT SUPPLY

LIGHT SUPPLY ADJUSTABLE TRIM

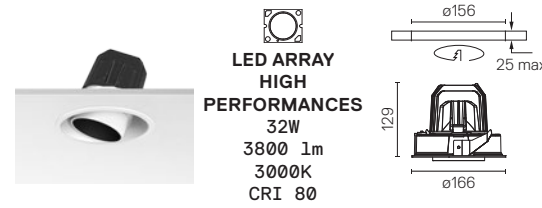

**LED ARRAY
HIGH
PERFORMANCES**
32W
3800 lm
3000K
CRI 80

Luminaria empotrable para fuente de luz LED. Fuente de alimentación remota 220/240V incluida.

Embedded luminaire for LED light source. Remote 220/240V power supply included.

- 3000K - CRI 80
TRIM
 03.6800.40
 03.6800.14
 Dali Version/1-10V
 03.6800.40.DA
 03.6800.14.DA
 NO TRIM
 03.6815.40
 03.6815.14
 Dali Version/1-10V
 03.6815.40.DA
 03.6815.14.DA



SPOT

[LIGHT SUPPLY ADJUSTABLE NO TRIM]



- 3000K - CRI 80
TRIM
 03.6801.40
 03.6801.14
 Dali Version/1-10V
 03.6801.40.DA
 03.6801.14.DA
 NO TRIM
 03.6816.40
 03.6816.14
 Dali Version/1-10V
 03.6816.40.DA
 03.6816.14.DA



MEDIUM

- 3000K - CRI 80
TRIM
 03.6802.40
 03.6802.14
 Dali Version/1-10V
 03.6802.40.DA
 03.6802.14.DA
 NO TRIM
 03.6817.40
 03.6817.14
 Dali Version/1-10V
 03.6817.40.DA
 03.6817.14.DA



FLOOD

LED INCL.
NOT REPLACEABLE

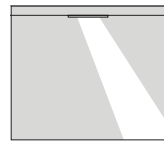
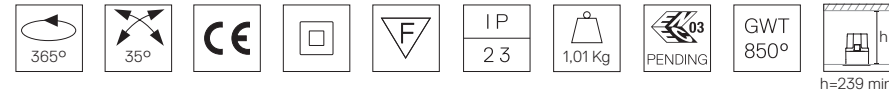

[Marco o Placa Soft Architecture para pre-instalación No Trim. Se ha de pedir por separado.
Pre-installation frame or Soft Architecture installation plate for No Trim installation. To be ordered separately.]

206

LIGHT SUPPLY

LIGHT SUPPLY ADJUSTABLE TRIM

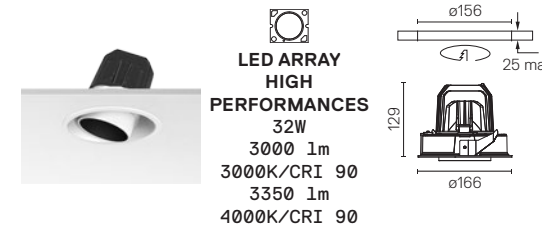

**LED ARRAY
HIGH
PERFORMANCES**
32W
3000 lm
3000K/CRI 90
3350 lm
4000K/CRI 90

Luminaria empotrable para fuente de luz LED. Fuente de alimentación remota 220/240V incluida.

Embedded luminaire for LED light source. Remote 220/240V power supply included.

- 3000K - CRI 90
TRIM
 03.6806.40
 03.6806.14
 Dali Version/1-10V
 03.6806.40.DA
 03.6806.14.DA
 NO TRIM
 03.6821.40
 03.6821.14
 Dali Version/1-10V
 03.6821.40.DA
 03.6821.14.DA



SPOT

[LIGHT SUPPLY ADJUSTABLE NO TRIM]



- 4000K - CRI 90
TRIM
 03.6803.40
 03.6803.14
 Dali Version/1-10V
 03.6803.40.DA
 03.6803.14.DA
 NO TRIM
 03.6818.40
 03.6818.14
 Dali Version/1-10V
 03.6818.40.DA
 03.6818.14.DA

- 3000K - CRI 90
TRIM
 03.6807.40
 03.6807.14
 Dali Version/1-10V
 03.6807.40.DA
 03.6807.14.DA
 NO TRIM
 03.6822.40
 03.6822.14
 Dali Version/1-10V
 03.6822.40.DA
 03.6822.14.DA



MEDIUM

- 4000K - CRI 90
TRIM
 03.6804.40
 03.6804.14
 Dali Version/1-10V
 03.6804.40.DA
 03.6804.14.DA
 NO TRIM
 03.6819.40
 03.6819.14
 Dali Version/1-10V
 03.6819.40.DA
 03.6819.14.DA

- 3000K - CRI 90
TRIM
 03.6808.40
 03.6808.14
 Dali Version/1-10V
 03.6808.40.DA
 03.6808.14.DA
 NO TRIM
 03.6823.40
 03.6823.14
 Dali Version/1-10V
 03.6823.40.DA
 03.6823.14.DA



FLOOD

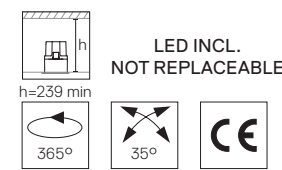

LED INCL.
NOT REPLACEABLE

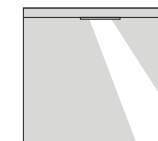

- 4000K - CRI 90
TRIM
 03.6805.40
 03.6805.14
 Dali Version/1-10V
 03.6805.40.DA
 03.6805.14.DA
 NO TRIM
 03.6820.40
 03.6820.14
 Dali Version/1-10V
 03.6820.40.DA
 03.6820.14.DA

207

LIGHT SUPPLY

LIGHT SUPPLY WALL-WASHER TRIM



**LED ARRAY
HIGH
PERFORMANCES**
32W
3800 lm
3000K/CRI 80
3000 lm
3000K/CRI 90
3350 lm
4000K/CRI 90

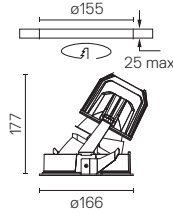

Luminaria empotrable para fuente de luz LED. Fuente de alimentación remota 220/240V incluida.

Embedded luminaire for LED light source. Remote 220/240V power supply included.

**3000K - CRI 80
TRIM**
E I
03.6812.3B
03.6812.3C
Dali Version/1-10V
03.6812.3B.DA
03.6812.3C.DA
03.6812.1B
03.6812.1C
Dali Version/1-10V
03.6812.1B.DA
03.6812.1C.DA

NO TRIM
03.6827.40
03.6827.06
Dali Version/1-10V
03.6827.40.DA
03.6827.06.DA

**3000K - CRI 90
TRIM**
E I
03.6814.3B
03.6814.3C
Dali Version/1-10V
03.6814.3B.DA
03.6814.3C.DA
03.6814.1B
03.6814.1C
Dali Version/1-10V
03.6814.1B.DA
03.6814.1C.DA

NO TRIM
03.6829.40
03.6829.06
Dali Version/1-10V
03.6829.40.DA
03.6829.06.DA

**4000K - CRI 90
TRIM**
E I
03.6813.3B
03.6813.3C
Dali Version/1-10V
03.6813.3B.DA
03.6813.3C.DA
03.6813.1B
03.6813.1C
Dali Version/1-10V
03.6813.1B.DA
03.6813.1C.DA

NO TRIM
03.6828.40
03.6828.06
Dali Version/1-10V
03.6828.40.DA
03.6828.06.DA

[LIGHT SUPPLY WALL-WASHER NO TRIM]

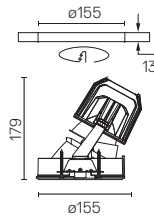

LED INCL.
NOT REPLACEABLE



E= Acabado Externo / I= Acabado Interno.
E= External Finish / I= Internal Finish.

[Marco de pre-instalación. Se ha de pedir por separado.]
[Pre-installation frame. To be ordered separately.]

LIGHT SUPPLY

ACCESORIOS / ACCESSORIES

Cruceta de apantallamiento. Screening crosspiece.		08.8242.14
Lente elíptica. Elliptical lens.		08.8118.68
Lente Flood. Flood lens.		08.8117.68
Honeycomb.		Celdas Pequeñas/ Small Cells 08.8049.14
Honeycomb.		Celdas Grandes/ Big Cells 08.8377.14
Cilindro de alta eficiencia. Highly-efficient cylinder.		08.8453.40 08.8453.14

Marco de pre-instalación. Pre-installation frame.		Adjustable No Trim 08.8119.00
		Fixed No Trim 08.8359.00
		Wall-Washer No Trim 08.8137.00

Placa Soft Architecture para pre-
instalación en superficies de cartón yeso. Adjustable No Trim
SA.6000.1

Soft Architecture installation plate for
integration in plasterboard.

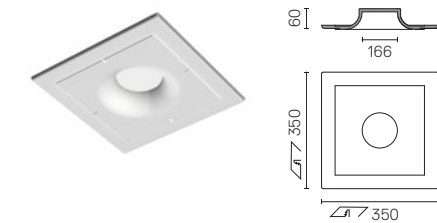

For Phosphor LED		Spot 08.8413.00
Reflector intercambiable para Light Supply Adjustable.		Medium 08.8414.00
Light Supply Adjustable spare reflector.		Flood 08.8415.00

For LED Array		Spot 08.8450.00
Reflector intercambiable para Light Supply Adjustable.		Medium 08.8451.00
Light Supply Adjustable spare reflector.		Flood 08.8452.00

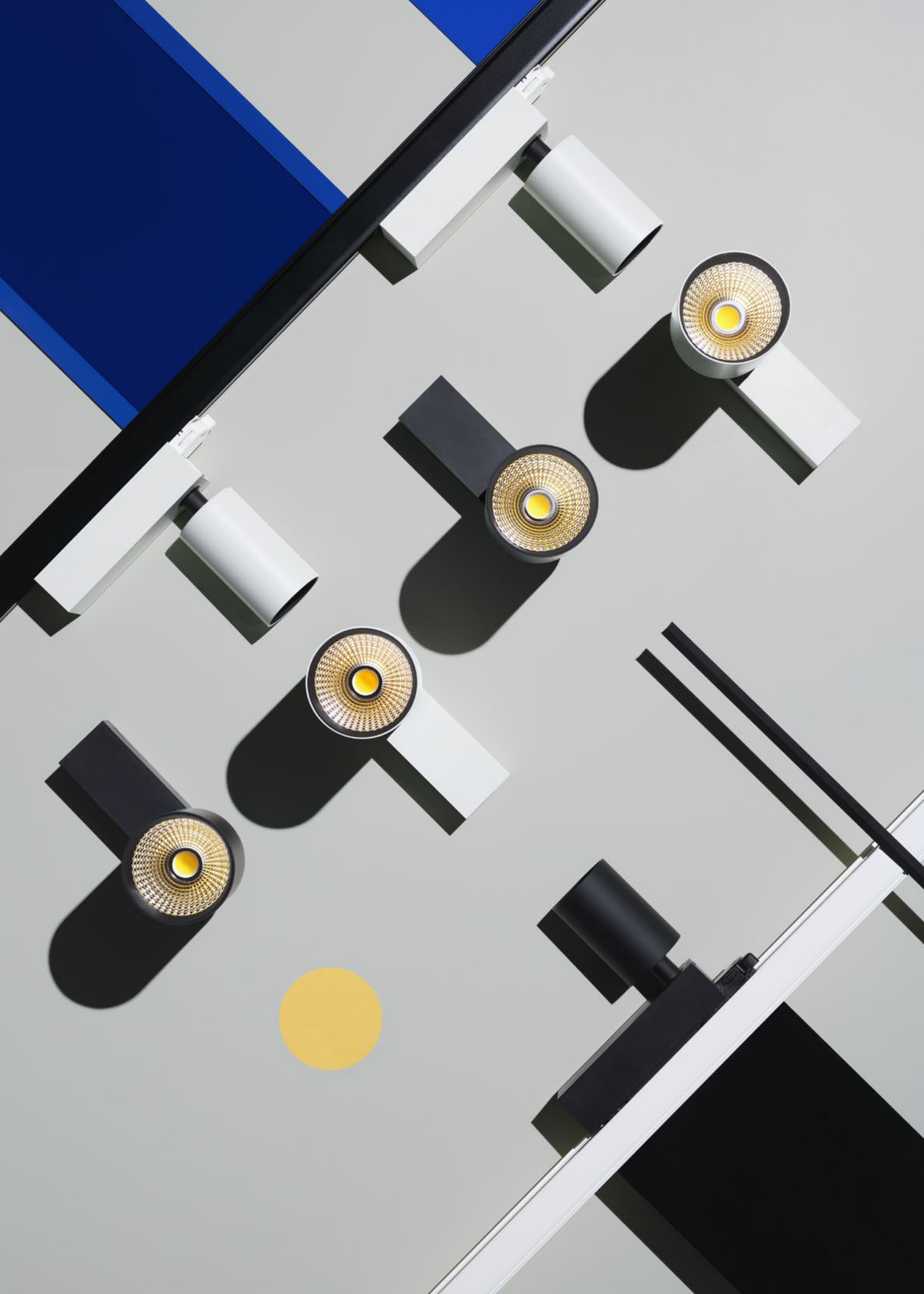

UT SPOT

Colección de proyectores LED de alta potencia de diseño minimalista y elegante. Gran variedad de soluciones, con fuentes luminosas y ópticas que pueden resolver cualquier necesidad de iluminación. Posibilidad de instalación en carril trifásico para la máxima flexibilidad o en techo para una mejor integración en la arquitectura. Eficiencia y fiabilidad.

UT SPOT

A collection of minimalist and elegant high-power LED projectors. A wide range of solutions with light sources and optics for all your lighting needs. Possibility of installing a three-phase track for maximum flexibility or on the roof for a better integration in the architecture. Efficiency and reliability.



DESIGNED BY FLOS ARCHITECTURAL





UT SPOT

Descripción

Luminaria de interior para ser instalada a carril trifásico o sobre techos, disponible con fuentes de luz de tecnología LED de alta potencia y en versión Dali y No Dali.

La familia está disponible en dos tamaños (Ø57 y Ø86) y en cinco versiones diferentes: Track (flexibilidad de instalación total), Ceiling (instalación independiente), Multichip (ángulos de apertura inferiores a 150°), Downlight (posición superior, funcionando como un downlight, o en su posición inferior, convirtiéndose en un proyector orientable) y Wall-Washer (solo versión Ø86).

El cuerpo óptico de la luminaria, así como el contenedor de los equipos de alimentación, están fabricados en aluminio inyectado a alta presión, acabados en pintura polvo de color blanco o negro.

Las luminarias a techo incluyen equipo de alimentación remoto.

Disponible en los acabados: blanco (40) y negro (14).

Unidades de Alimentación

Fuente de alimentación de corriente constante no regulable o regulable Dali 220-240V incluida.

Con potenciómetro incorporado en la versión track.

Accesorios

- Disponibles cruceta de apantallamiento, lente elíptica, lente Flood y Honeycomb.
- Marco de instalación NO TRIM (UT Downlight).
- Aro soporte (UT Spot ø86).

Información Adicional

Instalable sobre superficies normalmente inflamables.

Las luminarias de FLOS a carril trifásico estándar están diseñadas y completamente probadas para los carriles recomendados por FLOS. Su compatibilidad está garantizada con carriles trifásicos fabricados por Nordic Aluminium. Compatibilidad con Eutrac bajo pedido. Si desea confirmar su compatibilidad con otros carriles, póngase en contacto con FLOS antes de instalarlas.

Las luminarias de FLOS a carril trifásico DALI están diseñadas para el protocolo Pulse DALI de Nordic Aluminium.

- UT SPOT 86 (TRACK / CEILING):

Gracias a la remote-phosphor technology, los módulos LED que montan las versiones Phosphor LED ofrecen la máxima calidad de luz posible, percepción de los objetos y espacios, alcanzando índices de reproducción cromática de 98, dependiendo de las versiones.

Los módulos LED instalados en las versiones LED Array cuentan con la última generación tecnológica que permite una menor temperatura media en el funcionamiento de la electrónica. Gracias a esta característica, la luminaria puede operar dentro de parámetros de seguridad a una mayor potencia, ofreciendo una aumento del 20% del flujo luminoso.

Cumplimiento de Normativa y Marcas de Calidad

Luminaria conforme con la Normativa Técnica Europea EN60598-1 y partes segundas.

Description

A luminaire for indoor use to be mounted on three phase track or on ceilings, available in LED technology light sources and in DALI and non-DALI versions.

The family is available in two sizes (Ø57 / Ø86) and in five different versions: Track (totally flexible installation), Ceiling (stand-alone installation), Multichip (beam angles less than 150°), Downlight (up position, operates as a downlight, or in the down position, it becomes an adjustable spotlight) and Wall-Washer (only Ø86 version).

The optical housing of the luminaire, as well as the container of the power supply equipment, is manufactured in high-pressure injected aluminium, with white or black finishes.

Remote driver included in ceiling versions.

Available finishes: white (40) and black (14).

Power Supply

Not dimmable or dimmable Dali 220-240V, constant current, power supply included.

Track version with on-board potentiometer.

Accessories

- Screening crosspiece, elliptical lens, flood lens and Honeycomb.
- NO TRIM installation frame (UT Downlight).
- Support ring (UT Spot ø86).

Additional Information

Suitable for installation on normally inflammable surfaces.

FLOS three-phase lighting track luminaires are designed and fully tested for tracks recommended by FLOS. Compatibility is guaranteed with three-phase track produced by Nordic Aluminium. Compatibility with Eutrac under request. To verify compatibility with any other track, please contact FLOS before installation.

FLOS three-phase DALI track luminaires are designed for Pulse DALI from Nordic Aluminium.

- UT SPOT 86 (TRACK / CEILING):

Thanks to remote-phosphor technology, the LED modules of the Phosphor LED versions offer maximum quality light, the perception of objects and spaces, reaching chromatic reproduction indices of 98, depending on the version.

The LED modules installed on the LED Array versions have cutting-edge technology that permit a lower average temperature in the electronics. Thanks to this feature, the luminaire can operate at a higher power inside the safety parameters, yet still offer 20% added luminous flux.

Standard Compliance and Quality Marks

EN60598-1 European Technical Standards and any subsequent additions.

Colores Colours

□ 30 Blanco
30 White

■ 14 Negro
14 Black



Rotación Rotation Features

Puede ser rotado 360° y orientado 90°.
Can be rotated 360° and swivelled 90°.

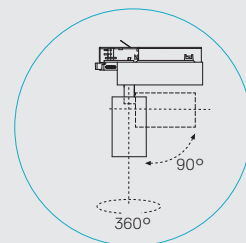

216

UT SPOT

TRACK Ø57



LED ARRAY

21,5W
2350 lm
3000K/CRI 80
21,5W
1900 lm
3000K/CRI 90
4000K/CRI 90



LED ARRAY

22W
2550 lm
3000K/CRI 80
22W
2100 lm
3000K/CRI 90
4000K/CRI 90

MULTICHIP Ø57



TOP LED

11,5W
750 lm
3000K/CRI 90
900 lm
3000K/CRI 80
930 lm
4000K/CRI 80

CEILING Ø57



LED ARRAY

21,5W
2350 lm
3000K/CRI 80
21,5W
1900 lm
3000K/CRI 90
4000K/CRI 90

DOWNLIGHT TRIM / NO TRIM Ø57



LED ARRAY

18W
2000 lm
3000K/CRI 80
18W
1600 lm
3000K/CRI 90
4000K/CRI 90

TRACK Ø86



PHOSPHOR LED

34,1W
3000 lm
3000K/CRI 98
29,3W
3000 lm
4000K/CRI 80



LED ARRAY HIGH PERFORMANCES

40W
4100 lm
3000K/CRI 80
40W
3500 lm
3000K/CRI 90
4000K/CRI 90

TRACK WALL-WASHER Ø86



LED ARRAY HIGH PERFORMANCES

40W
4100 lm
3000K/CRI 80
40W
3500 lm
3000K/CRI 90
4000K/CRI 90

MULTICHIP Ø86



TOP LED

11,5W
750 lm
3000K/CRI 90
900 lm
3000K/CRI 80
930 lm
4000K/CRI 80

CEILING Ø86



PHOSPHOR LED

34,1W
3000 lm
3000K/CRI 98
29,3W
3000 lm
4000K/CRI 80



LED ARRAY HIGH PERFORMANCES

40W
4100 lm
3000K/CRI 80
40W
3500 lm
3000K/CRI 90
4000K/CRI 90

DOWNLIGHT TRIM / NO TRIM Ø86



LED ARRAY HIGH PERFORMANCES

31W
3200 lm
3000K/CRI 80
31W
2600 lm
3000K/CRI 90
4000K/CRI 90

217

UT SPOT TRACK Ø57



LED ARRAY
21,5W
2350 lm
3000K/CRI 80

21,5W
1900 lm
3000K/CRI 90
4000K/CRI 90

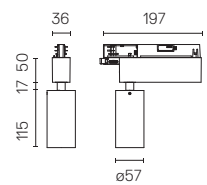

Proyector para ser instalado a carril trifásico con fuente de luz LED. Fuente de alimentación 220-240V, 50-60Hz integrada.

Spotlight to be installed on 3-phase track. with LED light source. 220-240V, 50-60Hz power supply integrated.

3000K - CRI 80
On board dimmer included
09.4440.30
09.4440.14
Non Dimmable
09.4480.30
09.4480.14



3000K - CRI 90
On board dimmer included
09.4443.30
09.4443.14
Non Dimmable
09.4486.30
09.4486.14

4000K - CRI 90
On board dimmer included
09.4450.30
09.4450.14
Non Dimmable
09.4481.30
09.4481.14

3000K - CRI 80
On board dimmer included
09.4441.30
09.4441.14
Non Dimmable
09.4482.30
09.4482.14



3000K - CRI 90
On board dimmer included
09.4444.30
09.4444.14
Non Dimmable
09.4487.30
09.4487.14

4000K - CRI 90
On board dimmer included
09.4451.30
09.4451.14
Non Dimmable
09.4483.30
09.4483.14

3000K - CRI 80
On board dimmer included
09.4442.30
09.4442.14
Non Dimmable
09.4484.30
09.4484.14



3000K - CRI 90
On board dimmer included
09.4445.30
09.4445.14
Non Dimmable
09.4488.30
09.4488.14

4000K - CRI 90
On board dimmer included
09.4452.30
09.4452.14
Non Dimmable
09.4485.30
09.4485.14

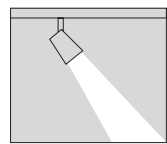
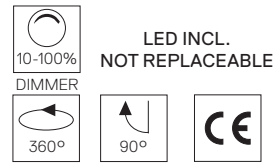

UT SPOT

UT SPOT TRACK DALI VERSION Ø57



LED ARRAY
22W
2550 lm
3000K/CRI 80

22W
2100 lm
3000K/CRI 90
4000K/CRI 90

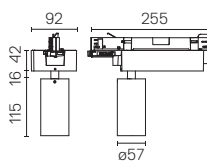

Proyector para ser instalado a carril trifásico con fuente de luz LED. Fuente de alimentación 220-240V, 50-60Hz integrada.

Spotlight to be installed on 3-phase track. with LED light source. 220-240V, 50-60Hz power supply integrated.

3000K - CRI 80
09.4440.30.DA
09.4440.14.DA

3000K - CRI 90
09.4443.30.DA
09.4443.14.DA



4000K - CRI 90
09.4450.30.DA
09.4450.14.DA

3000K - CRI 80
09.4441.30.DA
09.4441.14.DA



3000K - CRI 90
09.4444.30.DA
09.4444.14.DA

4000K - CRI 90
09.4451.30.DA
09.4451.14.DA

3000K - CRI 80
09.4442.30.DA
09.4442.14.DA



3000K - CRI 90
09.4445.30.DA
09.4445.14.DA

4000K - CRI 90
09.4452.30.DA
09.4452.14.DA

LED INCL. NOT REPLACEABLE

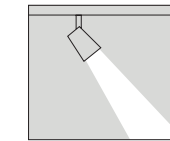

UT SPOT TRACK MULTICHIP Ø57



TOP LED
11,5W
750 lm
3000K/CRI 90

11,5W
900 lm
3000K/CRI 80

11,5W
930 lm
4000K/CRI 80

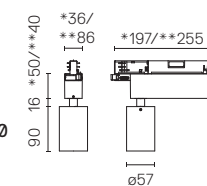

Proyector para ser instalado a carril trifásico con fuente de luz LED. Fuente de alimentación 220-240V, 50-60Hz integrada.

Spotlight to be installed on 3-phase track. with LED light source. 220-240V, 50-60Hz power supply integrated.

3000K - CRI 80
On board dimmer included
09.4970.30
09.4970.14
Non Dimmable
09.4973.30
09.4973.14



Dali Version
09.4970.30.DA
09.4970.14.DA

3000K - CRI 90
On board dimmer included
09.4971.30
09.4971.14
Non Dimmable
09.4974.30
09.4974.14
Dali Version
09.4971.30.DA
09.4971.14.DA

4000K - CRI 80
On board dimmer included
09.4972.30
09.4972.14
Non Dimmable
09.4975.30
09.4975.14
Dali Version
09.4972.30.DA
09.4972.14.DA

* Dimmable/Non Dim
**Dali Version

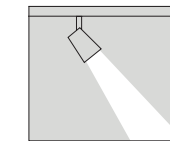
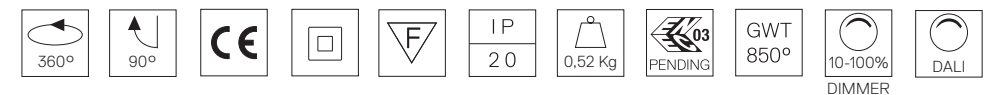

LED INCL. NOT REPLACEABLE

UT SPOT CEILING Ø57



LED ARRAY
21,5W
2350 lm
3000K/CRI 80

21,5W
1900 lm
3000K/CRI 90
4000K/CRI 90

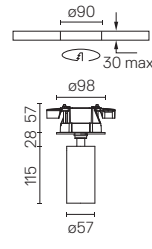

Proyector para ser instalado a techo con fuente de luz LED. Fuente de alimentación remota 220-240V, 50-60Hz incluida.

Spotlight to be installed on ceiling with LED light source. 220-240V, 50-60Hz remote power supply included.

- 3000K - CRI 80
Non Dimmable
09.4460.30
09.4460.14
Dali Version
09.4460.30.DA
09.4460.14.DA
- 3000K - CRI 90
Non Dimmable
09.4463.30
09.4463.14
Dali Version
09.4463.30.DA
09.4463.14.DA
- 4000K - CRI 90
Non Dimmable
09.4470.30
09.4470.14
Dali Version
09.4470.30.DA
09.4470.14.DA

- 3000K - CRI 80
Non Dimmable
09.4461.30
09.4461.14
Dali Version
09.4461.30.DA
09.4461.14.DA

- 3000K - CRI 90
Non Dimmable
09.4464.30
09.4464.14
Dali Version
09.4464.30.DA
09.4464.14.DA

- 4000K - CRI 90
Non Dimmable
09.4471.30
09.4471.14
Dali Version
09.4471.30.DA
09.4471.14.DA

- 3000K - CRI 80
Non Dimmable
09.4462.30
09.4462.14
Dali Version
09.4462.30.DA
09.4462.14.DA

- 3000K - CRI 90
Non Dimmable
09.4465.30
09.4465.14
Dali Version
09.4465.30.DA
09.4465.14.DA

- 4000K - CRI 90
Non Dimmable
09.4472.30
09.4472.14
Dali Version
09.4472.30.DA
09.4472.14.DA

LED INCL. NOT REPLACEABLE

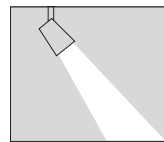

UT SPOT

UT SPOT DOWNLIGHT TRIM Ø57



LED ARRAY
18W
2000 lm
3000K/CRI 80

18W
1600 lm
3000K/CRI 90
4000K/CRI 90

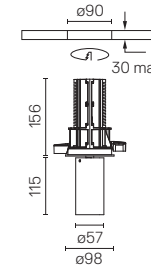

Luminaria empotrable para fuente de luz LED. Fuente de alimentación remota 220-240V, 50-60Hz incluida.

Embedded luminaire for LED light source. 220-240V, 50-60Hz remote power supply included.

- 3000K - CRI 80
Non Dimmable
09.4510.30
09.4510.14
Dali Version
09.4510.30.DA
09.4510.14.DA
- 3000K - CRI 90
Non Dimmable
09.4513.30
09.4513.14
Dali Version
09.4513.30.DA
09.4513.14.DA
- 4000K - CRI 90
Non Dimmable
09.4516.30
09.4516.14
Dali Version
09.4516.30.DA
09.4516.14.DA

- 3000K - CRI 80
Non Dimmable
09.4511.30
09.4511.14
Dali Version
09.4511.30.DA
09.4511.14.DA

- 3000K - CRI 90
Non Dimmable
09.4514.30
09.4514.14
Dali Version
09.4514.30.DA
09.4514.14.DA

- 4000K - CRI 90
Non Dimmable
09.4517.30
09.4517.14
Dali Version
09.4517.30.DA
09.4517.14.DA

- 3000K - CRI 80
Non Dimmable
09.4512.30
09.4512.14
Dali Version
09.4512.30.DA
09.4512.14.DA

- 3000K - CRI 90
Non Dimmable
09.4515.30
09.4515.14
Dali Version
09.4515.30.DA
09.4515.14.DA

- 4000K - CRI 90
Non Dimmable
09.4518.30
09.4518.14
Dali Version
09.4518.30.DA
09.4518.14.DA

LED INCL. NOT REPLACEABLE

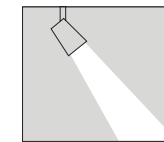

UT SPOT DOWNLIGHT NO TRIM Ø57

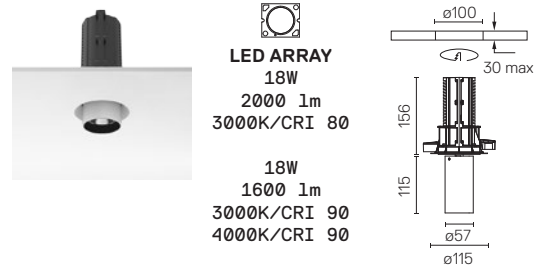

LED ARRAY
18W
2000 lm
3000K/CRI 80

18W
1600 lm
3000K/CRI 90
4000K/CRI 90

Luminaria empotrable para fuente de luz LED. Fuente de alimentación remota 220-240V, 50-60Hz incluida.

Embedded luminaire for LED light source. 220-240V, 50-60Hz remote power supply included.

3000K - CRI 80
Non Dimmable
09.4519.30
09.4519.14
Dali Version
09.4519.30.DA
09.4519.14.DA

3000K - CRI 90
Non Dimmable
09.4522.30
09.4522.14
Dali Version
09.4522.30.DA
09.4522.14.DA

4000K - CRI 90
Non Dimmable
09.4525.30
09.4525.14
Dali Version
09.4525.30.DA
09.4525.14.DA

3000K - CRI 80
Non Dimmable
09.4520.30
09.4520.14
Dali Version
09.4520.30.DA
09.4520.14.DA

3000K - CRI 90
Non Dimmable
09.4523.30
09.4523.14
Dali Version
09.4523.30.DA
09.4523.14.DA

4000K - CRI 90
Non Dimmable
09.4526.30
09.4526.14
Dali Version
09.4526.30.DA
09.4526.14.DA

3000K - CRI 80
Non Dimmable
09.4521.30
09.4521.14
Dali Version
09.4521.30.DA
09.4521.14.DA

3000K - CRI 90
Non Dimmable
09.4524.30
09.4524.14
Dali Version
09.4524.30.DA
09.4524.14.DA

4000K - CRI 90
Non Dimmable
09.4527.30
09.4527.14
Dali Version
09.4527.30.DA
09.4527.14.DA

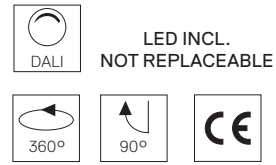

UT SPOT TRACK Ø86

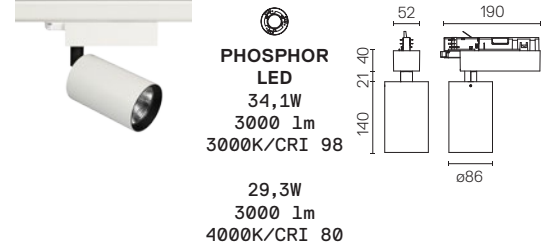

PHOSPHOR LED
34,1W
3000 lm
3000K/CRI 98

29,3W
3000 lm
4000K/CRI 80

Proyector para ser instalado a carril trifásico con fuente de luz LED. Fuente de alimentación 220-240V, 50-60Hz integrada.

Spotlight to be installed on 3-phase track. with LED light source. 220-240V, 50-60Hz power supply integrated.

3000K - CRI 98
On board dimmer included
09.4243.30
09.4243.14
Non Dimmable
09.4286.30
09.4286.14

4000K - CRI 80
On board dimmer included
09.4250.30
09.4250.14
Non Dimmable
09.4281.30
09.4281.14

3000K - CRI 98
On board dimmer included
09.4244.30
09.4244.14
Non Dimmable
09.4287.30
09.4287.14

4000K - CRI 80
On board dimmer included
09.4251.30
09.4251.14
Non Dimmable
09.4283.30
09.4283.14

3000K - CRI 98
On board dimmer included
09.4245.30
09.4245.14
Non Dimmable
09.4288.30
09.4288.14

4000K - CRI 80
On board dimmer included
09.4252.30
09.4252.14
Non Dimmable
09.4285.30
09.4285.14

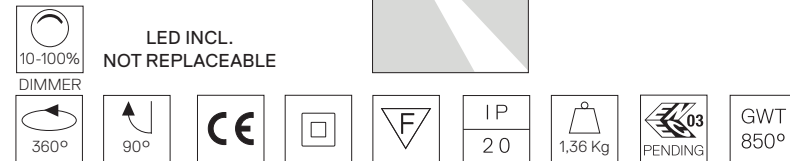
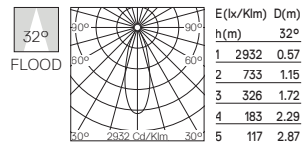
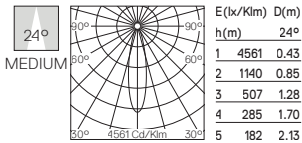
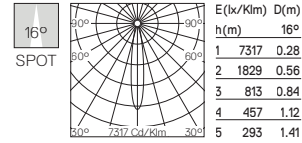

LED INCL. NOT REPLACEABLE

10-100% DIMMER

360° 90°

CE

IP 20

1,36 Kg

PENDING

GWT 850°

UT SPOT TRACK DALI VERSION Ø86

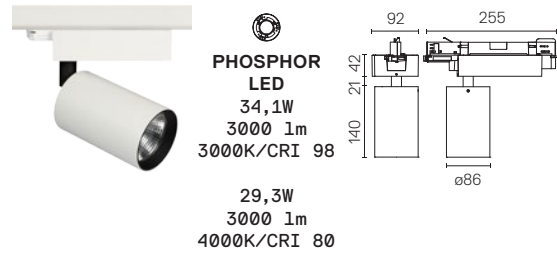

PHOSPHOR LED
34,1W
3000 lm
3000K/CRI 98

29,3W
3000 lm
4000K/CRI 80

Proyector para ser instalado a carril trifásico con fuente de luz LED. Fuente de alimentación 220-240V, 50-60Hz integrada.

Spotlight to be installed on 3-phase track. with LED light source. 220-240V, 50-60Hz power supply integrated.

- 3000K - CRI 98
 09.4243.30.DA
 09.4243.14.DA
- 4000K - CRI 80
 09.4250.30.DA
 09.4250.14.DA

- 3000K - CRI 98
 09.4244.30.DA
 09.4244.14.DA
- 4000K - CRI 80
 09.4251.30.DA
 09.4251.14.DA

- 3000K - CRI 98
 09.4245.30.DA
 09.4245.14.DA
- 4000K - CRI 80
 09.4252.30.DA
 09.4252.14.DA

DALI LED INCL. NOT REPLACEABLE

360° 90°

IP 20 1,18 Kg GWT 850°

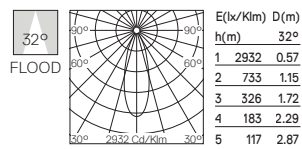
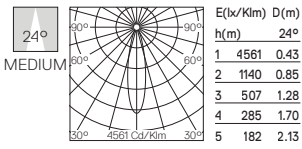
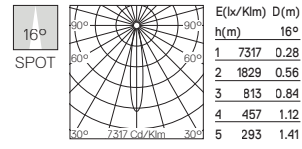
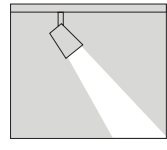

UT SPOT

UT SPOT TRACK Ø86

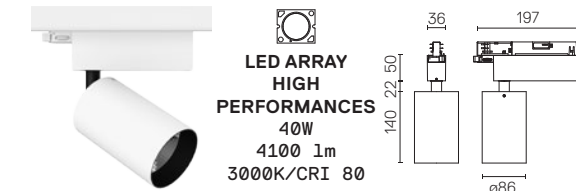

LED ARRAY HIGH PERFORMANCES
40W
4100 lm
3000K/CRI 80

40W
3500 lm
3000K/CRI 90
4000K/CRI 90

Proyector para ser instalado a carril trifásico con fuente de luz LED. Fuente de alimentación 220-240V, 50-60Hz integrada.

Spotlight to be installed on 3-phase track. with LED light source. 220-240V, 50-60Hz power supply integrated.

- 3000K - CRI 80
 09.4840.30
 09.4840.14
 Non Dimmable
- 3000K - CRI 90
 09.4880.30
 09.4880.14
 On board dimmer included

- 3000K - CRI 90
 09.4843.30
 09.4843.14
 Non Dimmable
- 4000K - CRI 90
 09.4886.30
 09.4886.14
 On board dimmer included

- 4000K - CRI 90
 09.4850.30
 09.4850.14
 Non Dimmable
- 4000K - CRI 90
 09.4881.30
 09.4881.14
 On board dimmer included

- 3000K - CRI 80
 09.4841.30
 09.4841.14
 Non Dimmable
- 3000K - CRI 90
 09.4882.30
 09.4882.14
 On board dimmer included

- 3000K - CRI 90
 09.4844.30
 09.4844.14
 Non Dimmable
- 4000K - CRI 90
 09.4887.30
 09.4887.14
 On board dimmer included

- 4000K - CRI 90
 09.4851.30
 09.4851.14
 Non Dimmable
- 4000K - CRI 90
 09.4883.30
 09.4883.14
 On board dimmer included

- 3000K - CRI 80
 09.4842.30
 09.4842.14
 Non Dimmable
- 3000K - CRI 90
 09.4884.30
 09.4884.14
 On board dimmer included

- 3000K - CRI 90
 09.4845.30
 09.4845.14
 Non Dimmable
- 4000K - CRI 90
 09.4888.30
 09.4888.14
 On board dimmer included

- 4000K - CRI 90
 09.4852.30
 09.4852.14
 Non Dimmable
- 4000K - CRI 90
 09.4885.30
 09.4885.14
 On board dimmer included

10-100% DIMMER LED INCL. NOT REPLACEABLE

360° 90°

IP 20 0,75 Kg GWT 850°

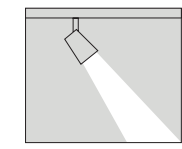

UT SPOT

UT SPOT TRACK DALI VERSION Ø86

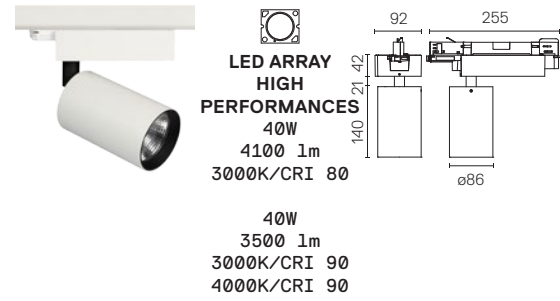

LED ARRAY HIGH PERFORMANCES
 40W
 4100 lm
 3000K/CRI 80

40W
 3500 lm
 3000K/CRI 90
 4000K/CRI 90

Proyector para ser instalado a carril trifásico con fuente de luz LED. Fuente de alimentación 220-240V, 50-60Hz integrada.

Spotlight to be installed on 3-phase track. with LED light source. 220-240V, 50-60Hz power supply integrated.

3000K - CRI 80
 09.4840.30.DA
 09.4840.14.DA

3000K - CRI 90
 09.4843.30.DA
 09.4843.14.DA

4000K - CRI 90
 09.4850.30.DA
 09.4850.14.DA

3000K - CRI 80
 09.4841.30.DA
 09.4841.14.DA

3000K - CRI 90
 09.4844.30.DA
 09.4844.14.DA

4000K - CRI 90
 09.4851.30.DA
 09.4851.14.DA

3000K - CRI 80
 09.4842.30.DA
 09.4842.14.DA

3000K - CRI 90
 09.4845.30.DA
 09.4845.14.DA

4000K - CRI 90
 09.4852.30.DA
 09.4852.14.DA

12°
 SPOT

23°
 MEDIUM

40°
 FLOOD

LED INCL. NOT REPLACEABLE



UT SPOT TRACK WALL-WASHER Ø86

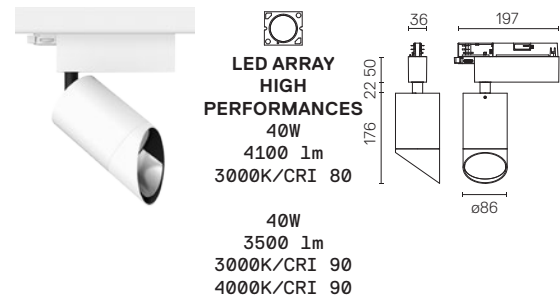

LED ARRAY HIGH PERFORMANCES
 40W
 4100 lm
 3000K/CRI 80

40W
 3500 lm
 3000K/CRI 90
 4000K/CRI 90

Proyector para ser instalado a carril trifásico con fuente de luz LED. Fuente de alimentación 220-240V, 50-60Hz integrada.

Spotlight to be installed on 3-phase track. with LED light source. 220-240V, 50-60Hz power supply integrated.

3000K - CRI 80
 On board dimmer included
 09.4950.30
 09.4950.14
 Non Dimmable

09.4951.30
 09.4951.14
 Dali Version

09.4950.30.DA
 09.4950.14.DA

3000K - CRI 90
 On board dimmer included
 09.4953.30
 09.4953.14
 Non Dimmable

09.4954.30
 09.4954.14
 Dali Version

09.4953.30.DA
 09.4953.14.DA

4000K - CRI 90
 On board dimmer included
 09.4956.30
 09.4956.14
 Non Dimmable

09.4957.30
 09.4957.14
 Dali Version

09.4956.30.DA
 09.4956.14.DA

LED INCL. NOT REPLACEABLE



UT SPOT

UT SPOT TRACK MULTICHIP Ø86

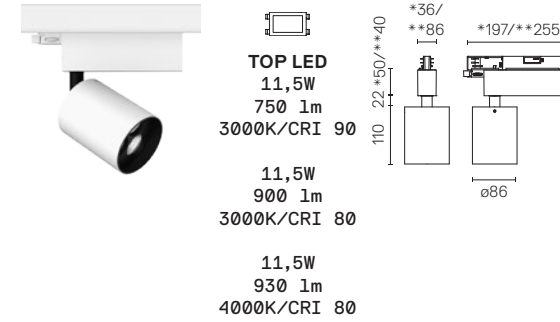

TOP LED
 11,5W
 750 lm
 3000K/CRI 90

11,5W
 900 lm
 3000K/CRI 80

11,5W
 930 lm
 4000K/CRI 80

Proyector para ser instalado a carril trifásico con fuente de luz LED. Fuente de alimentación 220-240V, 50-60Hz integrada.

Spotlight to be installed on 3-phase track. with LED light source. 220-240V, 50-60Hz power supply integrated.

3000K - CRI 80
 On board dimmer included
 09.4980.30
 09.4980.14
 Non Dimmable

09.4983.30
 09.4983.14
 Dali Version

09.4980.30.DA
 09.4980.14.DA

3000K - CRI 90
 On board dimmer included
 09.4981.30
 09.4981.14
 Non Dimmable

09.4984.30
 09.4984.14
 Dali Version

09.4981.30.DA
 09.4981.14.DA

4000K - CRI 80
 On board dimmer included
 09.4982.30
 09.4982.14
 Non Dimmable

09.4985.30
 09.4985.14
 Dali Version

09.4982.30.DA
 09.4982.14.DA

* Dimmable/Non Dim
 **Dali Version

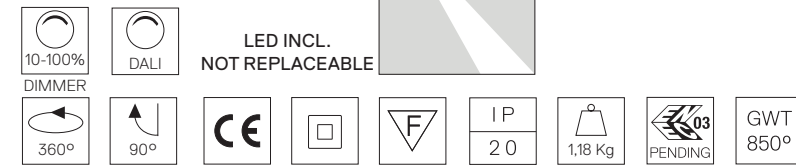

8°
 SUPER SPOT

UT SPOT CEILING Ø86



PHOSPHOR LED
34,1W
3000 lm
3000K/CRI 98

29,3W
3000 lm
4000K/CRI 80

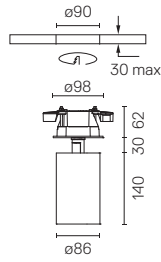

Proyector para ser instalado a techo con fuente de luz LED. Fuente de alimentación remota 220-240V, 50-60Hz incluida.

Spotlight to be installed on ceiling with LED light source. 220-240V, 50-60Hz remote power supply included.

3000K - CRI 98
Non Dimmable
09.4263.30
09.4263.14
Dali Version
09.4263.30.DA
09.4263.14.DA

4000K - CRI 80
Non Dimmable
09.4270.30
09.4270.14
Dali Version
09.4270.30.DA
09.4270.14.DA

3000K - CRI 98
Non Dimmable
09.4264.30
09.4264.14
Dali Version
09.4264.30.DA
09.4264.14.DA

4000K - CRI 80
Non Dimmable
09.4271.30
09.4271.14
Dali Version
09.4271.30.DA
09.4271.14.DA

3000K - CRI 98
Non Dimmable
09.4265.30
09.4265.14
Dali Version
09.4265.30.DA
09.4265.14.DA

4000K - CRI 80
Non Dimmable
09.4272.30
09.4272.14
Dali Version
09.4272.30.DA
09.4272.14.DA

DALI
LED INCL.
NOT REPLACEABLE

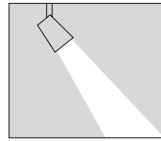

360° 90° IP 20 1,66 Kg PENDING GWT 850°

UT SPOT

UT SPOT CEILING Ø86



LED ARRAY HIGH PERFORMANCES
40W
4100 lm
3000K/CRI 80

40W
3500 lm
3000K/CRI 90
4000K/CRI 90

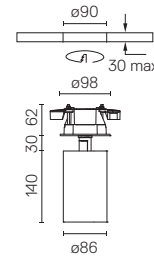

Proyector para ser instalado a techo con fuente de luz LED. Fuente de alimentación remota 220-240V, 50-60Hz incluida.

Spotlight to be installed on ceiling with LED light source. 220-240V, 50-60Hz remote power supply included.

3000K - CRI 80
Non Dimmable
09.4860.30
09.4860.14
Dali Version
09.4860.30.DA
09.4860.14.DA

3000K - CRI 90
Non Dimmable
09.4863.30
09.4863.14
Dali Version
09.4863.30.DA
09.4863.14.DA

4000K - CRI 90
Non Dimmable
09.4870.30
09.4870.14
Dali Version
09.4870.30.DA
09.4870.14.DA

3000K - CRI 80
Non Dimmable
09.4861.30
09.4861.14
Dali Version
09.4861.30.DA
09.4861.14.DA

3000K - CRI 90
Non Dimmable
09.4864.30
09.4864.14
Dali Version
09.4864.30.DA
09.4864.14.DA

4000K - CRI 90
Non Dimmable
09.4871.30
09.4871.14
Dali Version
09.4871.30.DA
09.4871.14.DA

3000K - CRI 80
Non Dimmable
09.4862.30
09.4862.14
Dali Version
09.4862.30.DA
09.4862.14.DA

3000K - CRI 90
Non Dimmable
09.4865.30
09.4865.14
Dali Version
09.4865.30.DA
09.4865.14.DA

4000K - CRI 90
Non Dimmable
09.4872.30
09.4872.14
Dali Version
09.4872.30.DA
09.4872.14.DA

DALI
LED INCL.
NOT REPLACEABLE

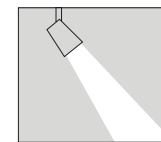

360° 90° IP 20 1,66 Kg PENDING GWT 850°

12°
SPOT

23°
MEDIUM

40°
FLOOD

UT SPOT DOWNLIGHT TRIM Ø86



LED ARRAY HIGH PERFORMANCES
 31W
 3200 lm
 3000K/CRI 80

31W
 2600 lm
 3000K/CRI 90
 4000K/CRI 90

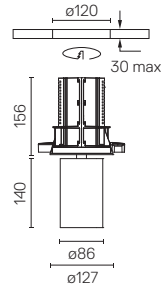

Luminaria empotrable para fuente de luz LED. Fuente de alimentación remota 220-240V, 50-60Hz incluida.

Embedded luminaire for LED light source. 220-240V, 50-60Hz remote power supply included.

- 3000K - CRI 80
 Non Dimmable
 09.4910.30
 09.4910.14
 Dali Version
 09.4910.30.DA
 09.4910.14.DA
- 3000K - CRI 90
 Non Dimmable
 09.4913.30
 09.4913.14
 Dali Version
 09.4913.30.DA
 09.4913.14.DA
- 4000K - CRI 90
 Non Dimmable
 09.4916.30
 09.4916.14
 Dali Version
 09.4916.30.DA
 09.4916.14.DA

- 3000K - CRI 80
 Non Dimmable
 09.4911.30
 09.4911.14
 Dali Version
 09.4911.30.DA
 09.4911.14.DA

- 3000K - CRI 90
 Non Dimmable
 09.4914.30
 09.4914.14
 Dali Version
 09.4914.30.DA
 09.4914.14.DA

- 4000K - CRI 90
 Non Dimmable
 09.4917.30
 09.4917.14
 Dali Version
 09.4917.30.DA
 09.4917.14.DA

- 3000K - CRI 80
 Non Dimmable
 09.4912.30
 09.4912.14
 Dali Version
 09.4912.30.DA
 09.4912.14.DA

- 3000K - CRI 90
 Non Dimmable
 09.4915.30
 09.4915.14
 Dali Version
 09.4915.30.DA
 09.4915.14.DA

- 4000K - CRI 90
 Non Dimmable
 09.4918.30
 09.4918.14
 Dali Version
 09.4918.30.DA
 09.4918.14.DA

LED INCL. NOT REPLACEABLE

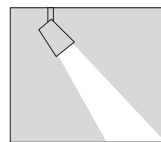

UT SPOT DOWNLIGHT NO TRIM Ø86



LED ARRAY HIGH PERFORMANCES
 31W
 3200 lm
 3000K/CRI 80

31W
 2600 lm
 3000K/CRI 90
 4000K/CRI 90

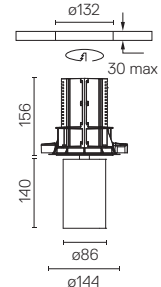

Luminaria empotrable para fuente de luz LED. Fuente de alimentación remota 220-240V, 50-60Hz incluida.

Embedded luminaire for LED light source. 220-240V, 50-60Hz remote power supply included.

- 3000K - CRI 80
 Non Dimmable
 09.4919.30
 09.4919.14
 Dali Version
 09.4919.30.DA
 09.4919.14.DA
- 3000K - CRI 90
 Non Dimmable
 09.4922.30
 09.4922.14
 Dali Version
 09.4922.30.DA
 09.4922.14.DA
- 4000K - CRI 90
 Non Dimmable
 09.4925.30
 09.4925.14
 Dali Version
 09.4925.30.DA
 09.4925.14.DA

- 3000K - CRI 80
 Non Dimmable
 09.4920.30
 09.4920.14
 Dali Version
 09.4920.30.DA
 09.4920.14.DA

- 3000K - CRI 90
 Non Dimmable
 09.4923.30
 09.4923.14
 Dali Version
 09.4923.30.DA
 09.4923.14.DA

- 4000K - CRI 90
 Non Dimmable
 09.4926.30
 09.4926.14
 Dali Version
 09.4926.30.DA
 09.4926.14.DA

- 3000K - CRI 80
 Non Dimmable
 09.4921.30
 09.4921.14
 Dali Version
 09.4921.30.DA
 09.4921.14.DA

- 3000K - CRI 90
 Non Dimmable
 09.4924.30
 09.4924.14
 Dali Version
 09.4924.30.DA
 09.4924.14.DA

- 4000K - CRI 90
 Non Dimmable
 09.4927.30
 09.4927.14
 Dali Version
 09.4927.30.DA
 09.4927.14.DA

LED INCL. NOT REPLACEABLE

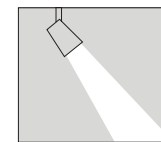

UT SPOT Ø57
ACCESORIOS / ACCESSORIES

Cruceta de apantallamiento, lentes y Honeycomb directamente instalables en la cabeza de la luminaria sin necesidad de accesorio de sujeción.
Compatibilidad de instalación de Honeycomb + Lente al mismo tiempo.

Screening crosspiece, lenses and Honeycomb directly installable on the head of the luminaire without needing any fastening accessory.
Installation compatible with Honeycomb + Lense at the same time.

UT Spot Ø57

Cruceta de apantallamiento. 08.8429.00
Screening crosspiece. 

Lente elíptica. 08.8431.00
Elliptical lens. 

Lente Flood. 08.8432.00
Flood lens. 

Honeycomb. 08.8428.00
Honeycomb. 

UT Spot Downlight

Marco de instalación NO TRIM. 08.8994.30
Installation frame NO TRIM.  08.8994.14

UT SPOT Ø86
ACCESORIOS / ACCESSORIES

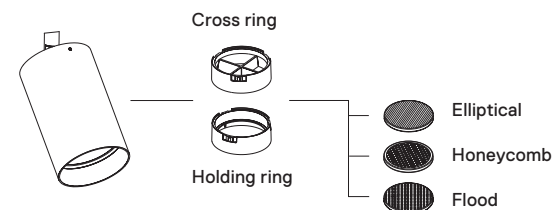

UT Spot Ø86

Aro soporte. 08.8410.00
Holding ring. 

Cruceta de apantallamiento. 08.8411.00
Screening crosspiece. 

Lente elíptica. 08.8163.68
Elliptical lens. 

Lente Flood. 08.8175.68
Flood lens. 

Honeycomb. 08.8495.14
Honeycomb. 

UT Spot Downlight

Marco de instalación NO TRIM. 08.8995.30
Installation frame NO TRIM.  08.8995.14



Sistema de ajuste mediante una guía dentada que permite que los proyectores se escondan, quedando integrados en el entorno.

An adjustment system on a toothed guide permits concealing the spotlights, thus becoming integrated into the environment.

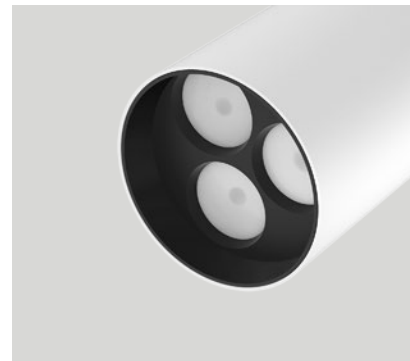

Óptica multichip para conseguir ángulos de apertura muy cerrados.

Multichip optical design to achieve very narrow beam angles.



Versión wall-washer disponible en la versión track de Ø86.

A wall-washer version is available in Ø86 track version.



DISTRIBUTION

BELGIUM AND LUXEMBOURG

Flos Belux
M +32 474 413 485
Fax +39 0302438.250
flosbelux@flos.com

FRANCE

Flos S.A.R.L.
15/17 Avenue de Ségur
75007 Paris
Tel +33 (0) 1 53 59 58 88
Fax +33 (0) 1 53 59 58 89
flos@flos.fr

GERMANY

Flos Spa
Tel +49 217310 93721
Fax +39 0302438.250
info@flos.com

UNITED KINGDOM

Atrium Ltd. offices & showroom
28 Leonard Street
EC2A 4BY London
Tel +44 (0)20 7681 9933
Fax +44 (0)20 7681 9943
flos@atrium.ltd.uk

DENMARK

Flos Scandinavia A/S
Sydhavnsgade 28
DK-2450 København SV
Tel +45 (0) 3388 60 00
Fax +45 (0) 3388 60 10
info@flos.dk

NORWAY

Flos Norge A/S
SjølystPlass 4
N-0278 Oslo
Tel +47 (0) 2212 86 00
Fax +47 (0) 2212 86 08
info@flos.no

THE NETHERLANDS

Flos BV
Cruquiusweg 109Q
1019 AG Amsterdam
Tel +31 (0) 20 560 50 60
Fax +31 (0) 20 560 50 70
info@flosmail.nl

U. S. A.

Flos USA Inc.
110 York Street - 5th Floor
Brooklyn, NY 11201
Tel +1 (718) 875-3472
Fax +1 (718) 875-3473
info@flosusa.com

JAPAN

Flos Co., Ltd.
PMC Building 9F
1-23-5 Higashiazabu Minato-Ku
Tokyo 104-0044
Tel +81 (0) 3 35 82 14 68
Fax +81 (0) 3 35 82 09 74
info@flosjapan.com

FAR EAST

Flos Representative Office 1,
Commonwealth Lane #08-12
149544 Singapore
Tel +65 (0) 6372 1495
flosasia@flos.com

CHINA

Flos illumination (Shanghai) Co. Ltd
Unit 2299, 22nd floor,
RM2299, 22/F
68 Yin Cheng Road (C)
Pudong District
Shanghai 200120, China
Tel +86-21-61946740
Fax +86-21-61946699
floschina@flos.com

SHOWROOMS

MILANO

Corso Monforte, 15
20122 Milano
Tel +39 02 79 84 57
Fax +39 02 89 78 56 41
contract.milano@flos.com

COPENAGHEN

Sydhavnsgade 28
DK-2450 København SV
Tel +45 (0) 3388 60 00
Fax +45 (0) 3388 60 10
info@flos.dk

AMSTERDAM

Cruquiusweg 109Q
1019 AG Amsterdam
Tel +31 (0) 20 560 50 60
Fax +31 (0) 20 560 50 70
info@flosmail.nl

OSLO

Sjølyst Plass 4
N-0278 Oslo
Tel +47 (0) 2212 86 00
Fax +47 (0) 2212 86 08
info@flos.no

TOKYO

PMC Building 9F
1-23-5 Higashiazabu Minato-Ku
Tokyo 104-0044
Tel +81 (0) 3 35 82 14 68
Fax +81 (0) 3 55 75 70 87
info@flosjapan.com

FLAGSHIP STORES

MILANO

Corso Monforte, 9
20122 Milano
Tel +39 02 37011080
Fax +39 02 37011081
flosmilano@flos.com

ROMA

Via del Babuino, 85
00187 Roma
Tel +39 06 3207631
Fax +39 06 3207690
flosroma@flos.com

PARIS

15, rue de Bourgogne
75007 Paris
Tel +33 (0)1 53 85 49 93
Fax +33 (0)1 53 85 49 99
shop@flos.fr

LYON

17 rue Jarente
69002 Lyon
Tel +33 478621301
Fax +33 478622119
lyon@flos.fr

HONG KONG

G/F Wyndham Place,
44 Wyndham Street
Central Hong Kong
Tel +852 2801 7608
Fax +852 2869 0722
dentropo@netvigator.com

STOCKHOLM

Karlaplan
Lützengatan 1
S-115-20 Stockholm
Tel +46 (0) 8 660 4405
Fax +46 (0) 8 660 7005
info@flos.se

NEW YORK

152 Greene Street
New York, NY 10012
Tel +1 212 941 4760
Fax +1 212 941 4763
info@flosusa.com

CREDITS

ART DIRECTION

Omar Sosa

GRAPHIC DESIGN

Studio Omar Sosa

LAYOUT

Flos Architectural Team

ART PHOTOGRAPHY

Carl Kleiner

IN-PLACE PHOTOGRAPHY

Rubén P. Bescós
Germán Cabo
Javier Orive
Jesus Granada
Eugeni Pons
Ángel Rosique
Germano Borrelli
David Zarzoso
BIS Images
Erlantz Biderbost
Germán Cabo
Jorge Allende
View Pictures Ltd / Alamy
Santi Caleca

PRINTED BY

Rumor Vicenza Italy

TECHNICAL

Jorge Herrera Studio

EDITION

August 2016
Copyright © Flos 2016
All rights reserved

PHOTO PRODUCT

Jorge Herrera
Mozing Studio

ACKNOWLEDGEMENTS

Clavel Arquitectos
Anja Karimian y Lliberós Salvador Arquitectos
Fran Silvestre Arquitectos
Galería Carreras Múgica
Nonna Design

CONTACT

ITALY

Flos Spa
Via Angelo Faini, 2
25073 Bovezzo (Brescia)
Tel +39 0302438.1
Fax +39 0302438.250
info@flos.com

SPAIN

Antares Iluminación S.A.U.
Calle Mallorca, 1
Polígono Industrial Reva
46394 Ribarroja (Valencia)
Tel +34 96 166 95 20
Fax +34 96 166 82 86
flos.architectural@flos.com

WWW.FLOS.COM